

# Solid-State Memory Camcorder

*PMW-200*

*PMW-100*

## Operating Instructions

Before operating the unit, please read this manual thoroughly and retain it for future reference.

---

**XDCAM**<sup>™</sup>

**SXS**

**HDMI**

**MPEG HD422**

**Exmor** **i**

## WARNING

**To reduce the risk of fire or electric shock, do not expose this apparatus to rain or moisture.**

**To avoid electrical shock, do not open the cabinet. Refer servicing to qualified personnel only.**

## WARNING

When installing the unit, incorporate a readily accessible disconnect device in the fixed wiring, or connect the power plug to an easily accessible socket-outlet near the unit. If a fault should occur during operation of the unit, operate the disconnect device to switch the power supply off, or disconnect the power plug.

## Important Safety Instructions

- Read these instructions.
- Keep these instructions.
- Heed all warnings.
- Follow all instructions.
- Do not use this apparatus near water.
- Clean only with dry cloth.
- Do not block any ventilation openings. Install in accordance with the manufacturer's instructions.
- Do not install near any heat sources such as radiators, heat registers, stoves, or other apparatus (including amplifiers) that produce heat.
- Do not defeat the safety purpose of the polarized or grounding-type plug. A polarized plug has two blades with one wider than the other. A grounding-type plug has two blades and a third grounding prong. The wide blade or the third prong are provided for your safety. If the provided plug does not fit into your outlet, consult an electrician for replacement of the obsolete outlet.
- Protect the power cord from being walked on or pinched particularly at plugs, convenience receptacles, and the point where they exit from the apparatus.
- Only use attachments/accessories specified by the manufacturer.
- Use only with the cart, stand, tripod, bracket, or table specified by the manufacturer, or sold with the apparatus.   
When a cart is used, use caution when moving the cart/apparatus combination to avoid injury from tip-over.
- Unplug this apparatus during lightning storms or when unused for long periods of time.

- Refer all servicing to qualified service personnel. Servicing is required when the apparatus has been damaged in any way, such as power-supply cord or plug is damaged, liquid has been spilled or objects have fallen into the apparatus, the apparatus has been exposed to rain or moisture, does not operate normally, or has been dropped.

Do not install the appliance in a confined space, such as book case or built-in cabinet.

## IMPORTANT

The nameplate is located on the bottom.

## WARNING

Excessive sound pressure from earphones and headphones can cause hearing loss. In order to use this product safely, avoid prolonged listening at excessive sound pressure levels.

## For the customers in the U.S.A.

This equipment has been tested and found to comply with the limits for a Class A digital device, pursuant to Part 15 of the FCC Rules. These limits are designed to provide reasonable protection against harmful interference when the equipment is operated in a commercial environment. This equipment generates, uses, and can radiate radio frequency energy and, if not installed and used in accordance with the instruction manual, may cause harmful interference to radio communications. Operation of this equipment in a residential area is likely to cause harmful interference in which case the user will be required to correct the interference at his own expense.

You are cautioned that any changes or modifications not expressly approved in this manual could void your authority to operate this equipment.

All interface cables used to connect peripherals must be shielded in order to comply with the limits for a digital device pursuant to Subpart B of Part 15 of FCC Rules.

This device complies with Part 15 of the FCC Rules. Operation is subject to the following two conditions: (1) this device may not cause harmful interference, and (2) this device must accept any interference received, including interference that may cause undesired operation.

## For the customers in Canada

This Class A digital apparatus complies with Canadian ICES-003.

### For the customers in Europe

This product with the CE marking complies with the EMC Directive issued by the Commission of the European Community. Compliance with this directive implies conformity to the following European standards:

- EN55103-1 : Electromagnetic Interference(Emission)
- EN55103-2 : Electromagnetic Susceptibility(Immunity)

This product is intended for use in the following Electromagnetic Environments: E1 (residential), E2 (commercial and light industrial), E3 (urban outdoors), E4 (controlled EMC environment, ex. TV studio).

The manufacturer of this product is Sony Corporation, 1-7-1 Konan, Minato-ku, Tokyo, 108-0075 Japan.

The Authorized Representative for EMC and product safety is Sony Deutschland GmbH, Hedelfinger Strasse 61, 70327 Stuttgart, Germany. For any service or guarantee matters please refer to the addresses given in separate service or guarantee documents.

### ATTENTION

The electromagnetic field at the specific frequencies may influence the picture and sound of this camera.

### For the State of California, USA only

Perchlorate Material - special handling may apply, See [www.dtsc.ca.gov/hazardouswaste/perchlorate](http://www.dtsc.ca.gov/hazardouswaste/perchlorate)

Perchlorate Material : Lithium battery contains perchlorate.

### For the customers in the USA and Canada RECYCLING LITHIUM-ION BATTERIES

Lithium-Ion batteries are recyclable. You can help preserve our environment by returning your used rechargeable batteries to the collection and recycling location nearest you.

For more information regarding recycling of rechargeable batteries, call toll free 1-800-822-8837, or visit <http://www.rbrbc.org/>

Caution: Do not handle damaged or leaking Lithium-Ion batteries.



### For the customers in Taiwan only



廢電池請回收

### For the Customers in Brazil only DESCARTE DE PILHAS E BATERIAS

Após o uso, as pilhas e/ou baterias poderão ser entregues ao estabelecimento comercial ou rede de assistência técnica autorizada.



### Bateria de Ion-Lítium

#### Atenção:

Se a bateria não for manuseada corretamente, ela poderá explodir, causar incêndio ou até mesmo queimaduras químicas. Observe as seguintes precauções.

- Não desmonte, esmague ou exponha a bateria a qualquer choque ou impacto, como martelar, deixar cair ou pisar.
- Não provoque curto-circuito, nem deixe que objetos metálicos entrem em contato com os terminais da bateria.
- Não exponha a bateria a temperaturas elevadas, acima de 60 °C, como sob a luz solar direta ou no interior de um carro estacionado ao sol.
- Não incinere nem jogue no fogo.
- Não manuseie baterias de íon-lítio danificadas ou com vazamentos
- Mantenha a bateria fora do alcance de crianças pequenas.
- Mantenha a bateria seca
- Substitua apenas por uma bateria do mesmo tipo ou equivalente recomendada pela Sony.

### Bateria Primária

#### Atenção:

Verifique as instruções de uso do aparelho certificando-se de que as polaridades (+) e (-) estão no sentido indicado. As pilhas poderão vazar ou explodir se as polaridades forem invertidas, expostas ao fogo, desmontadas ou recarregadas. Evite misturar com pilhas de outro tipo ou com pilhas usadas, transportá-las ou armazená-las soltas, pois aumenta o risco de vazamento. Retire as pilhas caso o aparelho não esteja sendo utilizado, para evitar possíveis danos na eventualidade de ocorrer vazamento. As pilhas devem ser armazenadas em local seco e ventilado.

No caso de vazamento da pilha, evite o contato com a mesma. Lave qualquer parte do corpo afetado com água abundante. Ocorrendo irritação, procure auxílio médico. Não remova o invólucro da pilha. Mantenha fora do alcance das crianças. Em caso de ingestão procure auxílio médico imediatamente.

# Table of Contents

---

## Overview

<b>Features</b> .....	<b>10</b>
<b>Part Identification</b> .....	<b>12</b>
Camcorder .....	12
IR Remote Commander (Supplied) .....	18
<b>On-Screen Indications</b> .....	<b>19</b>
Direct Menu Operation .....	20

---

## Preparations

<b>Power Supply</b> .....	<b>21</b>
Using a Battery Pack .....	21
Using AC Power (DC IN Power) .....	22
Turning the Power On/Off .....	22
<b>Setting the Clock</b> .....	<b>22</b>
<b>Adjusting the LCD Monitor and Viewfinder</b> .....	<b>23</b>
Adjusting the LCD Monitor .....	23
Adjusting the Viewfinder .....	23
<b>Using the IR Remote Commander</b> .....	<b>24</b>
<b>Using SxS Memory Cards</b> .....	<b>25</b>
About SxS Memory Cards .....	25
Inserting/Removing an SxS Memory Card .....	25
Switching Between SxS Memory Cards .....	26
Formatting an SxS Memory Card .....	26
Checking the Remaining Time Available for Recording .....	26
Restoring an SxS Memory Card .....	26
<b>Using an External Hard Disk</b> .....	<b>27</b>
Attaching/Removing the PHU-220R .....	27
Formatting the PHU-220R .....	28
Checking the Remaining Time Available for Recording .....	28
Restoring the PHU-220R .....	28
<b>Using Other Media</b> .....	<b>29</b>
XQD Memory Cards .....	29
“Memory Stick” media/SDHC Cards .....	30
USB Flash Drives (PMW-200 only) .....	30

<b>Using a Wi-Fi Adapter (PMW-200 only)</b> .....	<b>32</b>
Fixing the CBK-WA01 .....	32
Making a Wi-Fi Connection .....	33
Using the Web Menu .....	34

---

## Recording

<b>Basic Operation Procedure</b> .....	<b>36</b>
<b>Changing Basic Settings</b> .....	<b>38</b>
Video Formats .....	38
ND Filter (PMW-200 only) .....	38
White Balance .....	39
Markers/Zebra Patterns .....	40
Gain .....	40
Electronic Shutter .....	40
Iris (PMW-200) / Exposure (PMW-100) .....	41
Zoom .....	41
Focus .....	42
Steady Shot .....	43
NightShot (PMW-100 only) .....	43
Flickers .....	44
Time Data .....	44
<b>Recording Audio Signals</b> .....	<b>45</b>
Using the Built-in Stereo Microphones .....	45
Using External Inputs .....	45
Using an External Microphone .....	45
Adjusting the Audio Recording Levels .....	45
Monitoring the Audio .....	46
<b>Useful Functions</b> .....	<b>46</b>
Color Bars/Reference Tone .....	46
Shot Marks .....	46
OK/NG/KP Flags (for UDF Only) .....	47
OK Mark (for FAT HD Mode Only) .....	47
Rec Review .....	47
Assignable Buttons .....	48
Interval Recording .....	48
Frame Recording .....	48
Clip Continuous Recording (UDF Only) .....	49
Picture Cache Recording: Retroactively Record .....	50
Slow & Quick Motion .....	50
Freeze Mix: Image Alignment .....	51
Picture Profiles .....	52
Deleting Clips .....	59
Storing/Retrieving the Setting Data .....	59
Planning Metadata .....	60

---

## Playback

<b>Thumbnail Screens .....</b>	<b>63</b>
Configuration of the Thumbnail Screen .....	63
Changing the Type of Thumbnail Screen .....	64
<b>Playing Clips .....</b>	<b>65</b>
Playing the Selected and Subsequent Clips in Sequence .....	65
Monitoring Audio .....	66
Cueing Up .....	66
Adding Shot Marks During Playback (UDF and FAT HD Mode) .....	66
<b>Clip Operations .....</b>	<b>66</b>
Clip Operation Menus .....	66
Basic Operations of the Clip Operation Menus .....	67
Displaying the Detailed Information of a Clip .....	68
Adding/Deleting a Flag (UDF Only) .....	69
Adding/Deleting the OK Mark (FAT HD Mode Only) .....	69
Copying Clips .....	69
Deleting Clips .....	70
Displaying the EXPAND CLIP Screen .....	70
Displaying the SHOT MARK Screen (UDF and FAT HD Mode) .....	71
Adding/Deleting Shot Marks (UDF and FAT HD Mode) .....	72
Changing the Index Frame (UDF and FAT HD Mode) .....	72
Dividing a Clip (FAT HD Mode Only) .....	73

---

## Status Displays

<b>Showing the Status Screens .....</b>	<b>74</b>
Camera Status Screen .....	74
Audio Status Screen .....	75
Video Status Screen .....	75
Button/Remote Status Screen .....	75
Battery/Media Status Screen .....	76

---

## Menu Configuration and Detailed Settings

<b>Overview of the Setup Menus .....</b>	<b>77</b>
Setup Menu Layers .....	77
<b>Basic Menu Operations .....</b>	<b>78</b>
<b>Setup Menu List .....</b>	<b>80</b>

CAMERA SET Menu .....	80
AUDIO SET Menu .....	86
VIDEO SET Menu .....	88
LCD/VF SET Menu .....	89
TC/UB SET Menu .....	92
OTHERS Menu .....	94

---

## Connecting External Devices

<b>Connecting External Monitors and Recording Devices ....</b>	<b>103</b>
<b>Operating Clips With a Computer .....</b>	<b>104</b>
<b>Connecting via i.LINK (FAT only) .....</b>	<b>106</b>
Recording the Camcorder Picture on an External Device .....	106
Nonlinear Editing .....	107
Recording External Input Signals .....	107
<b>External Synchronization .....</b>	<b>108</b>

---

## Appendices

<b>Important Notes on Operation .....</b>	<b>110</b>
<b>Formats and Limitations of Outputs .....</b>	<b>112</b>
Video Formats and Output Signals .....	112
Limitations of Inputs/Outputs .....	118
<b>Backup Battery Replacement .....</b>	<b>120</b>
<b>Troubleshooting .....</b>	<b>121</b>
Power .....	121
Recording/Playback .....	121
External Devices .....	122
<b>Error/Warning Indications .....</b>	<b>123</b>
Error Indications .....	123
Warning Indications .....	123
<b>Licenses .....</b>	<b>126</b>
MPEG-2 Video Patent Portfolio License .....	126
Bitmap Fonts .....	126
On accessing software to which the GPL applies .....	126
<b>About OpenSSL .....</b>	<b>127</b>
<b>Specifications .....</b>	<b>130</b>
General .....	130
Lens .....	132
Camera Block .....	132
Inputs/Outputs .....	133
Displays .....	134



Internal Microphone .....	134
Media Slot Block .....	134
Package Configuration .....	134
Optional Accessories .....	134
<b>Index .....</b>	<b>136</b>

## Overview

# Features

The PMW-200/100 is a highly compact and high-performance XDCAM<sup>1</sup>) camcorder that uses SxS<sup>1</sup>) memory cards as recording media. The imaging device used in the PMW-200 camcorder is a 1/2-inch triple-chip type “Exmor”<sup>1</sup>) CMOS sensor, and the PMW-100 camcorder uses a 1/2.9-inch single-chip type “Exmor”<sup>1</sup>) CMOS sensor. Both have an effective pixel count of 1920 × 1080. Either the UDF or FAT file system can be used with recording media.

---

### Multiple-format support

Both Interlace at 1080/59.94i (or 1080/50i) and Progressive at 1080/29.97P, 1080/23.98P, 720/59.94P, 720/29.97P, and 720/23.98P (or 1080/25P, 720/50P, and 720/25P) are supported, providing various HD recording formats for worldwide coverage.

NTSC/PAL SD formats are also possible, including SD signal recording and playback in DVCAM format, as well as down-conversion output of HD signals into SD signals.

---

### A new generation HD recording system

#### HD recording using the “MPEG-2 Long GOP” codec and SD recording in DVCAM format

The PMW-200/100 records 1920 × 1080, 1440 × 1080, and 1280 × 720 HD images using “MPEG-2 Long GOP” codec compression. When recording with UDF, settings of 50 Mbps (in HD422 mode) or 35 Mbps (in HQ mode) are supported. With FAT, settings of 35 Mbps (in HQ mode) or 25 Mbps (in SP mode) are supported. When using UDF with a 64 GB SxS memory card, efficient compression methods allow for recording approximately 120 minutes of HD images at 50 Mbps (in HD422 mode), and approximately 180 minutes of HD images at 35 Mbps (in HQ mode). Furthermore, the PMW-200/100 supports recording and playback in DVCAM 25 Mbps format, as well as playback in MPEG IMX 50 Mbps format.

#### High-quality uncompressed audio recording

When in UDF HD422 mode, this camcorder can record 4-channel audio in 24-bit, 48 kHz linear

PCM format. Recording of 4-channel audio in 16-bit, 48 kHz linear PCM format for FAT HD Mode is possible.

#### Support for a file-based workflow

File-based recording in MXF and MP4 formats allows material to be handled with great flexibility in computer work environments, enabling easy copying, transferring, sharing, and archiving.

#### Instant-access thumbnail display with “Expand” function

Each time a recording is started and stopped, the video and audio signals are recorded as one clip. Furthermore, thumbnails are automatically generated for each clip as a visual reference, allowing the operator to cue-up to a desired scene simply by guiding the cursor to a thumbnail. For further convenience, the ‘Expand’ function allows one selected clip in the Thumbnail display to be divided into 12 equal time intervals, each with its own thumbnail identifier. This is useful if you wish to quickly search for a particular scene within a lengthy clip.

---

### Creative recording modes and settings

#### Versatile focus-assistance functions

The lens has a versatile functions for easy and precise focus adjustments.

- One-push Auto Focus
- MF Assist
- Expanded Focus
- Peaking

#### Slow & Quick Motion function

By using different settings for the recording framerate and playback framerate, you can perform high-quality slow-motion and quick-motion recording.

#### Slow Shutter function

This camcorder enables the capturing of clear, low-noise images in low-light environments, with long exposure of up to 64 frames.

#### Selectable gamma curves

Gamma curves can be selected based on the scenes being recorded.

### Interval Recording function

You can perform intermittent recording at pre-determined intervals. This is convenient for shortening the time it takes to track variations over long periods, such as changes in the weather or plant growth.

### Frame Recording function

Frame Recording is a unique feature of the PMW-200/100 camcorder that is especially useful for clay-animation shooting. With this function, images for pre-determined frame are recorded each time the record button is pressed.

### Shutter-angle settings

In addition to the electric shutter speed controls, the PMW-200/100 also has a “shutter angle” control, which is familiar to cinematographers.

### Picture Profile feature

The Picture Profile feature allows the camera operator to easily call up customized picture-tonal settings to suit particular shooting conditions.

Up to 6 groups of settings can be set.

### Picture Cache Recording function

The unit can utilize its internal memory to store the image being captured, allowing recording to commence up to 15 seconds in advance of when the REC START (recording start) button was pressed.

- 1) Sony, XDCAM, SxS, i.LINK, Exmor, and Remote Commander are trademarks of Sony Corporation.
- 2) HDMI, HDMI logo and High-Definition Multimedia Interface are trademarks or registered trademarks of HDMI Licensing, LLC in the United States and other countries.

All other trademarks are the property of their respective owners.

---

## A variety of functions and designs for high operability

---

- Depth-of-field indicator
- Brightness-level display
- Histogram indicator
- 3.5-inch color LCD monitor
- Easy-to-see color viewfinder
- Assignable buttons (Five assignable buttons for PMW-200, four for PMW-100)
- Zoom and recording start/stop operations enabled both on the handle and the grip
- Long operating time with a battery pack
- Wide array of interfaces, including USB, i.LINK<sup>1)</sup>, and HDMI<sup>2)</sup>
- ATW (Auto Tracing White Balance)
- Selectable gain
- High-speed picture search: ×4, ×15, ×24
- Freeze Mix function
- IR Remote Commander<sup>1)</sup> supplied
- Planning metadata function

# Part Identification

For functions and usage, see the pages in parentheses.

## Camcorder

### PMW-200

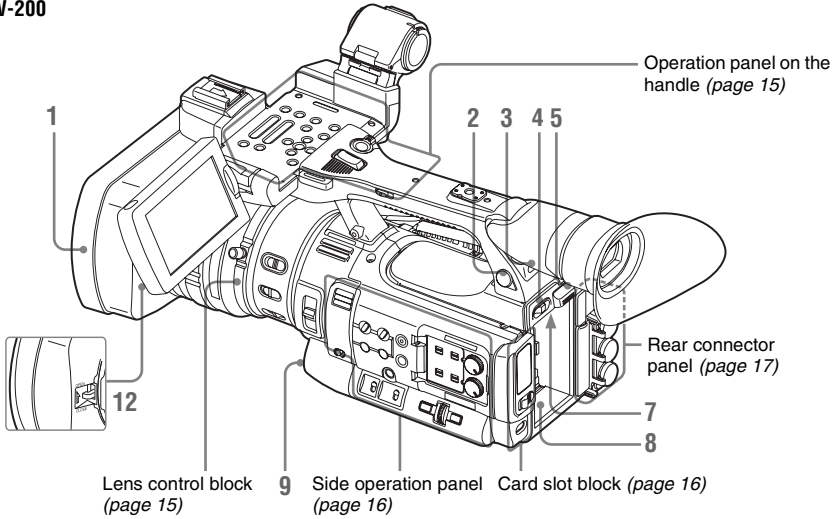

### PMW-100

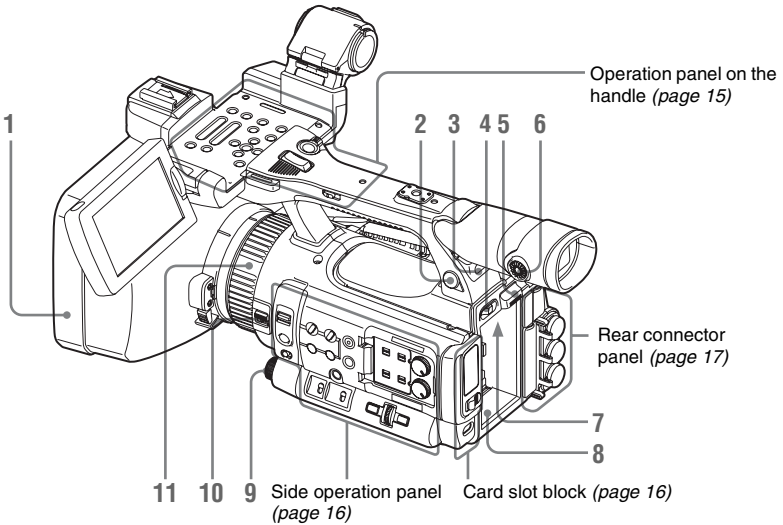

## 1. Lens hood

### PMW-200

#### Attach

Insert the hood by aligning it with the mark on the camcorder and hood, and turn the hood clockwise while facing the front of the camcorder (in the opposite direction of the arrow at ② in the illustration below), then tighten the hood fixing screw ①.

#### Detach

① Loosen the hood fixing screw, ② turn the hood in the direction of the arrow, ③ then withdraw it.

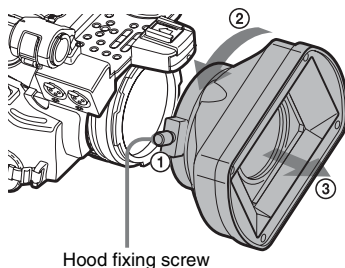

### PMW-100

#### Attach

Insert the hood by aligning it with the mark on the camcorder, then turn the hood clockwise while facing the front of the camcorder (opposite the direction at ② in the illustration below) to secure it.

#### Detach

① Press and hold the hood release button, ② turn the hood in the direction of the arrow, ③ then pull it out.

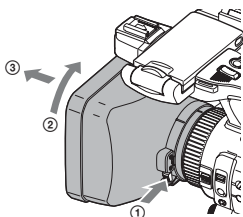

When attaching the optional wide-conversion lens, use the lens hood supplied with the wide-conversion lens.

## 2. Headphone connector (stereo mini jack) (page 46)

## 3. Rear IR remote control receptor

## 4. Power switch (page 22)

## 5. BATT RELEASE button (page 21)

## 6. Eyepiece focusing knob (PMW-100 only) (page 23)

## 7. DC IN connector (page 22)

## 8. Battery pack receptacle (page 21)

## 9. EXPOSURE dial/button (PMW-100) (page 41) /WHITE BAL (automatic white balance adjustment) button (PMW-200) (page 39)

## 10. FOCUS/ZOOM switch (PMW-100 only) (page 42)

## 11. Lens operation ring (PMW-100 only) (page 42)

## 12. Lens cap open/close lever (PMW-200 only) (page 36)

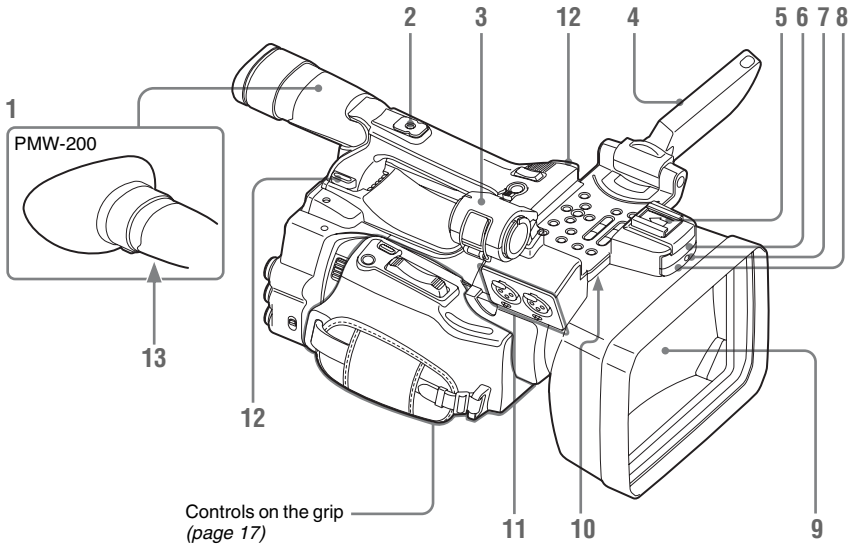

**1. Viewfinder (page 23)**

**How to attach the EVF large eyecup**

**PMW-200**

Stretch the EVF large eyecup for attaching to the viewfinder and insert it aligning with the horizontal groove of the eyecup.

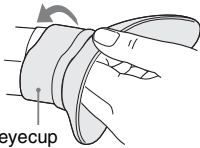

EVF large eyecup

**PMW-100**

Attach the EVF large eyecup, aligning it with the groove of the eyecup already installed on the unit.

Do not detach the eyecup already installed on the unit.

EVF large eyecup (supplied)

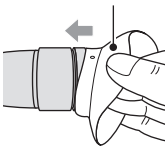

**2. Rear accessory shoe (page 27)**

**3. External microphone holder (page 45)**

**4. LCD (Liquid Crystal Display) monitor (page 23)**

**5. Front accessory shoe**

**6. Built-in microphone (page 45)**

**7. REC/TALLY lamp**

**8. Front IR remote control receptor/ NightShot IR transmitter (PMW-100 only) (page 43)**

**9. Lens cap (PMW-100 only)**

Remove the lens cap before recording. If you pull the lens cap strap in the direction of the arrow ① and move it near the grip, the lens cap will not disturb the recording.

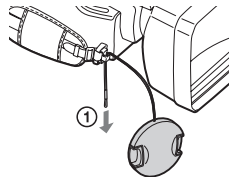

**10. Built-in speaker (page 66)**

**11. AUDIO IN CH-1/CH-2 connectors (XLR) and input selection (LINE/MIC/ MIC+48V) switches (page 45)**

**12. Hooks for the shoulder strap**

Attach the supplied shoulder strap as shown below.

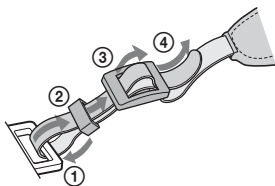

13. Eyepiece focusing knob (PMW-200 only)  
(page 23)

### Operation panel on the handle

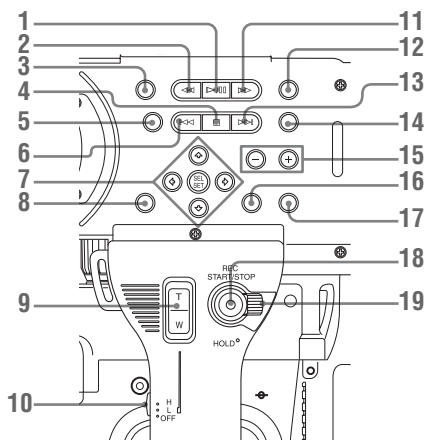

1. PLAY/PAUSE button (page 65)  
 2. F REV (fast reverse) button (page 66)  
 3. THUMBNAIL button (page 63)  
 4. STOP/CAM button (page 63)  
 5. STATUS (status display on/off) button  
(page 74)  
 6. PREV (previous) button  
 7. Up/down/left/right buttons, SEL/SET  
(select/set) button (page 78)  
 8. MENU (menu display on/off) button (page  
78)  
 9. On-handle ZOOM button (page 42)  
 10. Zoom speed switch (page 74)  
 11. F FWD (fast forward) button (page 66)  
 12. LCD BRIGHT (LCD brightness  
adjustment) button (page 23)  
 13. NEXT (clip directional jump) button  
(page 66)  
 14. DISPLAY button (page 19)

15. VOLUME (monitor volume) buttons  
(page 46)  
 16. CANCEL button  
 17. DURATION/TC/U-BIT (time data  
selection) button (page 44)  
 18. REC START/STOP button (page 37)  
 19. REC HOLD lever (page 37)

### Lens control block (PMW-200 only)

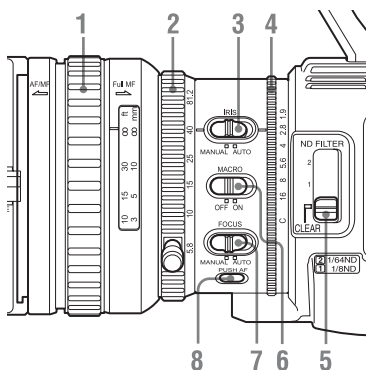

1. Focus ring (page 42)  
 2. Zoom ring (page 41)  
 3. IRIS switch (page 41)  
 4. Iris ring (page 41)  
 5. ND FILTER select switch (page 38)  
 6. MACRO switch (page 43)  
 7. FOCUS switch (page 42)  
 8. PUSH AF (momentary auto focus) button  
(page 43)

## Side operation panel

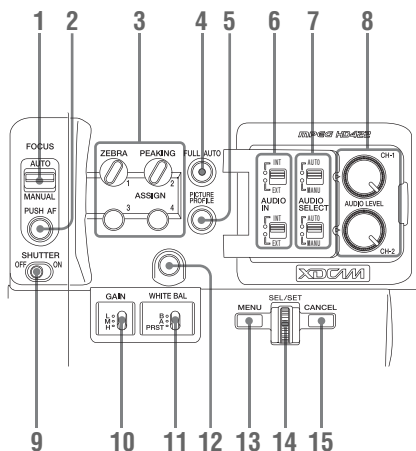

1. **FOCUS (focus adjustment mode) switch (PMW-100 only) (page 42)**
2. **PUSH AF (momentary auto focus) button (PMW-100 only) (page 43)**
3. **ASSIGN (assignable) 1/2/3/4 buttons (page 48)**  
ZEBRA is set to ASSIGN 1 and PEAKING is set to ASSIGN 2 by default.
4. **FULL AUTO button and indicator (page 36)**
5. **PICTURE PROFILE button (page 52)**
6. **AUDIO IN (audio input selection) switches (page 45)**
7. **AUDIO SELECT (audio level control mode selection) switches (page 45)**
8. **AUDIO LEVEL CH-1/CH-2 knobs (page 46)**
9. **SHUTTER switch (page 40)**
10. **GAIN switch (page 40)**
11. **WHITE BAL (white balance memory) switch (page 39)**
12. **WHITE BAL (automatic white balance adjustment) button (PMW-100) (page 39) /ASSIGN (assignable) 5 button (PMW-200) (page 48)**
13. **MENU (menu display on/off) button (page 78)**
14. **SEL/SET dial (jog dial) (page 78)**

It functions accordingly when you turn it up or down, or you push it horizontally. It is called the “jog dial” in the subsequent operating instructions.

## 15. CANCEL button

## Card slot block

The SxS memory card slots and EJECT buttons are located behind the cover.

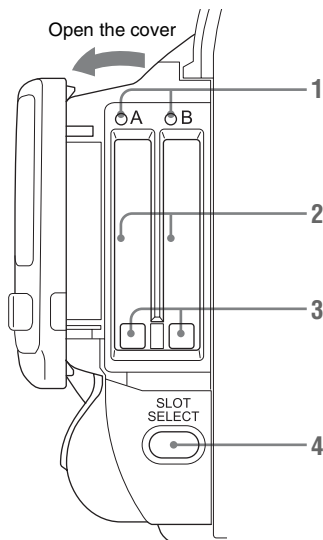

1. **ACCESS lamps (page 25)**
2. **SxS memory card slots (page 25)**
3. **EJECT (SxS memory card eject) buttons (page 25)**
4. **SLOT SELECT (SxS memory card select) button (page 26)**



## Rear connector panel

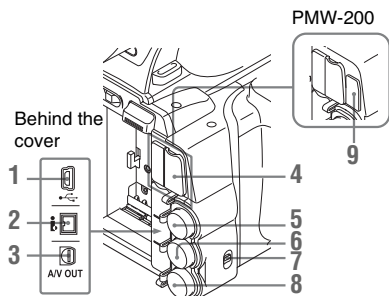

1. USB connector (Mini B)
2. i.LINK (HDV/DV) connector (4-pin, S400 conforming to IEEE1394) (page 103)
3. A/V OUT connector (audio/video multi output) (page 104)
4. HDMI OUT connector (page 103)
5. SDI OUT connector (BNC type) (page 103)
6. TC IN (timecode input)/TC OUT (timecode output) connector (BNC type) (page 109)
7. IN/OUT (input/output change) switch (page 109)  
Set this to IN to select GENLOCK IN, and set this to OUT to select TC OUT and VIDEO OUT.
8. GENLOCK IN/VIDEO OUT (analog video output) connector (BNC type) (page 103, 109)
9. External device connector (PMW-200 only) (page 30)

## Controls on the grip

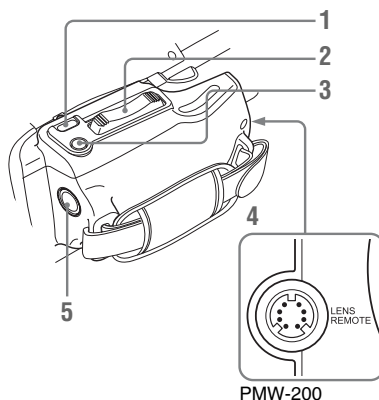

1. REC REVIEW button (page 37)
2. Power zoom lever (page 42)
3. EXPANDED FOCUS button (page 42)
4. LENS REMOTE (lens remote controller) connector (PMW-200 only) (page 42)
5. REC START (start/stop recording) button (page 37)

## Bottom

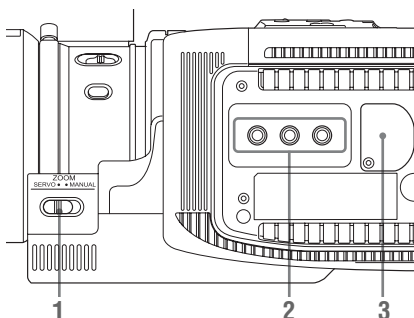

1. ZOOM (zoom mode switching) switch (PMW-200 only) (page 41)
2. Tripod receptacles

### Note

Check that the size of the hole matches the screw of the tripod. If they do not match, the camcorder cannot be attached to the tripod securely, and this may lead to the physical injury of the camera operator.

### 3. Backup battery holder (page 120)

## IR Remote Commander (Supplied)

The buttons without remarks can be used in the same manner as the corresponding buttons on the camcorder.

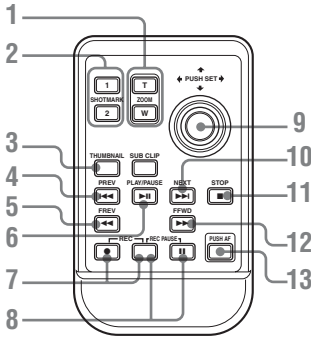

**1. ZOOM T/W (telephoto/wide-angle) buttons**

**2. SHOTMARK 1 and 2 buttons (page 46, page 66)**

**3. THUMBNAIL button**

**4. PREV (previous clip jump) button**

**5. F REV (fast reverse) button**

**6. PLAY/PAUSE button**

**7. REC (record) buttons**

Press the ● button together with the unmarked button (safety button) to start recording.

**8. REC PAUSE buttons**

Press the ■ button together with the unmarked button (safety button) to pause recording.

**9. PUSH SET button (four-way arrow key)**

It functions the same as the SEL/SET button on the camcorder.

**10. NEXT button**

**11. STOP button**

**12. F FWD (fast forward) button**

**13. PUSH AF button**

#### Note

The SUB CLIP button has no function.

# On-Screen Indications

While recording (or standing by to record), pressing the DISPLAY button displays the statuses and settings of this unit on the LCD monitor/viewfinder screen.

## Remarks

- [M]: The indication of the items named with this suffix can be independently turned on/off with “Display On/Off” in the LCD/VF SET menu (page 90).
- [A]: The indication of items named with this suffix can be turned on/off using the assignable buttons to which the corresponding on/off functions have been assigned (page 48).
- [D]: The settings of the items named with this suffix can be changed using the Direct menu on the screen (page 20).

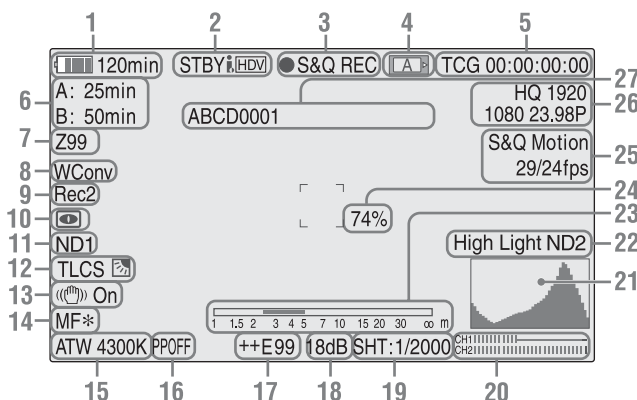

### 1. Battery remaining/DC IN voltage indication [M] (page 21)

### 2. i.LINK status indication (page 106)

Only when an external device is connected to the i.LINK connector, the status of the device is displayed.

### 3. Special recording/operation status indication

● REC	Recording in progress
STBY	Standby for recording When using Clip Continuous Recording, indicates that there is no continuing clip.
CONT	Standby for recording When using Clip Continuous Recording, indicates that a clip is being continued.
● S&Q REC	Slow & Quick Motion recording in progress

S&Q STBY	Standby for Slow & Quick Motion recording
● INT REC	Interval Recording in progress
INT STBY	Standby for Interval Recording
● FRM REC	Frame Recording in progress
FRM STBY	Standby for Frame Recording
● CACHE	● in green: Standby for Cache Recording ● in red: Cache Recording in progress

### 4. Media status indication

[A]	Memory card in slot A is active.
[B]	Memory card in slot B is active.

### 5. Time data indication [M] (page 44)

### 6. Media remaining indication [M] (page 26)



### 7. Zoom position indication [M] (page 41)

**8. Wide-conversion lens setting indicator**  (page 85)

Displayed when Wide Conversion of the CAMERA SET menu is set to “On”.



**9. Synchronous recording display** 









Displayed when “SDI Rec Control” in the VIDEO SET menu is set to “HD SDI Remote I/F.”

**10. NightShot mode indication (PMW-100 only)**   (page 43)**11. ND FILTER position (PMW-200 only)** 







Displays the selected ND filter number (page 38).

**12. TLCS mode indication**   (page 84)

	Backlight mode
	Standard mode
	Spotlight mode

**13. Steady Shot indication**   (page 43)**14. Focus mode indication**   only in MF mode) (page 42)**15. White balance mode and color temperature indications**   (page 39)**16. Picture profile indication**   (page 52)**17. Exposure position indication (PMW-100) / Iris position indication (PMW-200)**   (page 41)

Displays the brightness index. In Auto mode, “AUTO” is displayed.

**18. Gain indication**   (page 40)**19. Shutter mode/shutter speed indication**   (page 40)**20. Audio level meters** **21. Histogram indication**  **22. Video level cautioning indication**  /ND filter number indication (PMW-200 only)**23. Depth-of-Field bar indication**  **24. Brightness level indication**  **25. Special recording mode indication**   only in Slow & Quick Motion Standby)

Frame Rec	Frame Rec mode
Interval Rec	Interval Rec mode
S&Q Motion	Slow & Quick Motion mode
xx/xx fps	

**26. Video Format indication**  (page 38)**27. Clip name indication**  (page 37)**Direct Menu Operation**

The settings of the items named with a suffix  can be changed using the Direct menu on the screen.

Select “All,” “Part,” or “Off” for Direct Menu using “Direct Menu” (page 96) in the OTHERS menu.

**Note**

When the indicator of the FULL AUTO button is lit, the Direct Menu operation is disabled for the functions that are forcibly set to the automatic mode in Full Auto mode (page 36).

**1 When the camcorder’s status or settings are displayed on the screen, press the SEL/SET button (page 15) or the jog dial (page 16).**

If “Direct Menu” is set to “All” or “Part,” the cursor is displayed on one of the items for which the Direct menu operation is permitted.

**2 Press the up/down/left/right buttons (page 15) or rotate the jog dial to set the cursor to the item to be operated, then press the SEL/SET button or the jog dial.**

The Direct menu of the selected items appears.

**3 Press the up/down/left/right buttons or the jog dial to select a setting, then press the SEL/SET button or the jog dial.**

The menu disappears, and the new setting is displayed.

You can use a battery pack or AC power via an AC adaptor.

For safety, use only the Sony battery packs and AC adaptor listed below:

### Lithium-ion Battery Pack

BP-U30

BP-U60

BP-U90

### Battery Charger/AC Adaptor

BC-U1

BC-U2

### WARNING

Batteries shall not be exposed to excessive heat such as sunshine, fire or the like.

### Note

The AC adaptor cannot be connected to the camcorder while the battery pack is inserted.

## Using a Battery Pack

Fully insert the battery pack into the battery pack receptacle (*page 13*), then slide it to the left to lock it.







To remove the battery pack, press and hold the BATT RELEASE button (*page 13*), slide the battery pack upward to unlock it, then pull it out.

### Notes

- Before use, charge the battery pack with the supplied BC-U1 or BC-U2 Battery Charger.
- A warm battery pack immediately after use may not be able to be fully recharged.
- The high-capacity BP-U90 Battery Pack is large, and protrudes from the camcorder when attached. When using the camcorder with the BP-U90 attached for extended recording periods, Sony recommends attaching the camcorder to a tripod for convenience.

## Checking battery charge remaining

When recording or playback is in progress on the battery pack, an icon to show the current battery charge level and usage time remaining are displayed on the LCD monitor/viewfinder screen (*page 19*).

Icon	Remaining
	100% to 91%
	90% to 71%
	70% to 51%
	50% to 31%
	30% to 11%
	10% to 0%

The camcorder indicates the remaining usage time in minutes by calculating the available time with the battery pack if operation is continued at the current rate of power consumption.

## If the battery charge remaining becomes low

If the battery charge remaining decreases to a certain level during operation (Low BATT status), a low-battery message, flashing of the tally lamps, and a beep sound will warn you. If the remaining further decreases to a level at which operation cannot be continued (BATT Empty status), a battery-empty message appears. Replace the battery pack with one that is fully charged.

### To change the message levels

The Low BATT level is set to 10% of full charge, and the BATT Empty level is set to 3% of full charge at the factory. These settings can be changed with "Battery Alarm" (*page 96*) in the OTHERS menu.

## Using AC Power (DC IN Power)

Connection example: when connecting BC-U1

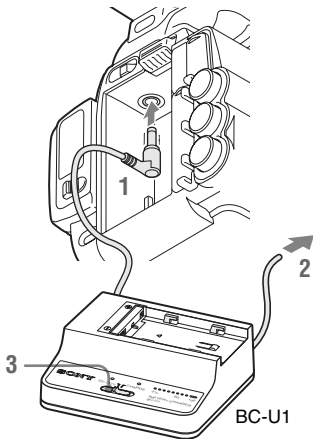

- 1 Connect the DC power output cable of the BC-U1 to the DC IN connector of the camcorder.
- 2 Connect the power cord of the BC-U1 to an AC power source.
- 3 Set the mode switch of the BC-U1 to the DC OUT position.

## Turning the Power On/Off

To turn the power on, set the power switch (*page 13*) to the ON position (the **I** position). To turn the power off, set the power switch to the OFF position (the **⏻** position).

### Notes

- This camcorder uses a little standby power even when the power switch is set to OFF. Remove the battery pack if the camcorder will not be used for a prolonged period.
- When removing the battery pack or the DC IN power, be sure to first set the power switch to the OFF position. Removing the battery pack or the DC IN power while the camcorder is ON may cause damage to the camcorder or the SxS memory card.

## Setting the Clock

When you turn the camcorder on for the first time after purchasing or replacing the backup battery (*page 120*), the Initial Setting display appears on the LCD monitor/viewfinder screen.

Set the date and time of the built-in clock, using this display.

### Time Zone

The value shows the time difference from UTC (Coordinated Universal Time).

Change the setting if needed.

### Setting the time and date

Press the up/down/left/right buttons (*page 15*) or turn the jog dial (*page 16*) to move the cursor, then press the SEL/SET button or the jog dial to set each menu item. When you press the SEL/SET button or the jog dial when the cursor is on “Finish,” the Initial Setting display disappears, the clock setting is completed, and the camcorder enters the mode selected via the power switch.

After the Initial Setting display disappears, “Time Zone” (*page 94*) and “Clock Set” (*page 94*) in the OTHERS menu can be used to set “Time Zone” and “Date/Time.”

### Notes

- If the clock setting is cleared because of exhaustion of the backup battery while no operation power was being supplied (no battery pack and no DC IN connection), the Initial Setting display will be displayed when you turn the camcorder on at the next opportunity.
- While the Initial Setting display is shown, no other operation except turning the power off is permitted until you finish the setting for this display.

## Adjusting the LCD Monitor and Viewfinder

### Adjusting the LCD Monitor

The LCD monitor turns on when it is opened and turns off when it is returned to the park position.

#### Adjusting the angle

It can be rotated as much as 90 degrees in the direction facing the subject and as much as 180 degrees in the opposite direction.

When you rotate it 90 degrees toward the subject, the image on the monitor becomes upside down, indicating the mirror image of the subject. The display direction of the textual information is converted to the readable direction.

#### Adjusting the backlight

Press the LCD BRIGHT button (*page 15*) to adjust the brightness of the backlight.

#### Adjusting the color, contrast, and brightness

These adjustments can be made using “LCD” (*page 89*) in the LCD/VF SET menu. These adjustments of the LCD monitor have no effect on pictures being recorded.

### Adjusting the Viewfinder

If the picture on the LCD monitor is hard to view under bright ambient light, you can use the viewfinder to check the picture.

#### Caution

Do not leave the camcorder with the eyepiece of the viewfinder facing the sun. Direct sunlight can enter through the eyepiece, be focused in the viewfinder, and cause fire.

Hereafter the viewfinder is referred to as “EVF” (abbreviation of Electronic Viewfinder).

### Turning the EVF on/off

With the factory setting, the EVF is turned on when the LCD monitor is in its park position or is rotated to face the subject.

You can change the setting so that the EVF is always on regardless of the status in the LCD monitor, using “EVF” (*page 89*) in the LCD/VF SET menu. Change the “Power” setting from “Auto” to “On.”

### Adjusting the focus in the EVF

The eyepiece focusing (diopter compensation) knob (*page 15*) (PMW-200)/(*page 13*) (PMW-100) enables adjustment to match the eyesight of the operator, who can then view the image clearly through the eyepiece.

### Adjusting the backlight

The brightness of the backlight for the EVF can be switched between High and Low. Set “Backlight” in “EVF” (*page 89*) in the LCD/VF SET menu.

### Switching between color and monochrome modes

For the EVF screen, color or monochrome display can be selected.

Set “Mode” in “EVF” (*page 89*) in the LCD/VF SET menu.

Select “B&W” if checking the subject and focusing are easier on the monochrome display. If you assign “EVF Mode” to one of the assignable buttons (*page 48*), you can switch between color and monochrome by pressing the button.

### Adjusting the contrast and brightness

Use “EVF” (*page 89*) in the LCD/VF SET menu to make adjustments. Adjusting the brightness and other items has no effect on pictures being recorded.

## Using the IR Remote Commander

### Before use

Before you use the supplied IR Remote Commander for the first time, pull out the insulation sheet from the battery holder.

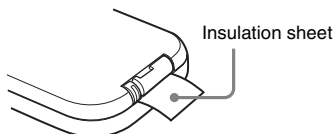

A CR2025 lithium battery is set in the holder at the factory.

### To use the IR Remote Commander

For controlling the camcorder from the IR Remote Commander, activate the remote control function of the camcorder after turning the power on.

Activating/deactivating the remote control function can be achieved using the Setup menu or an assignable button.

#### To activate using the menu

Press the MENU button to set the camcorder to Menu mode, select  (the OTHERS menu (page 94)) and set "IR Remote" to "On."

#### To activate using an assignable button

Assigning "IR Remote" to one of the assignable buttons (page 48) permits you to activate/deactivate the remote control function by pressing the button.

#### Note

To avoid malfunctions, the remote control function is automatically deactivated when the camcorder is turned off. Activate the function each time when required after you turn the camcorder on.

### Replacing the battery in the IR Remote Commander

Use a commercially available CR2025 lithium battery. Do not use any battery other than a CR2025.

- 1 Hold down the lock lever ①, pull out the battery holder ②, and remove the battery.

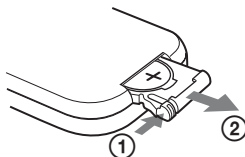

- 2 Place a new battery in the battery holder with the + symbol facing upward ①, then push the battery holder into the IR Remote Commander until it clicks ②.

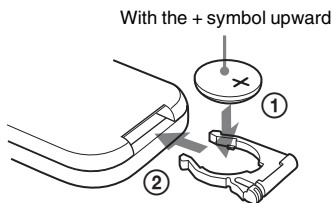

#### WARNING

- Battery may explode if mistreated. Do not recharge, disassemble, or dispose of in fire.
- Batteries shall not be exposed to excessive heat such as sunshine, fire or the like.

#### CAUTION

Danger of explosion if battery is incorrectly replaced. Replace only with the same or equivalent type recommended by the manufacturer.

When you dispose of the battery, you must obey the law in the relative area or country.



## Using SxS Memory Cards

This camcorder records audio and video on SxS memory cards (optional) inserted in the card slots.

### About SxS Memory Cards

#### Usable SxS memory cards

Use the following Sony-made SxS memory cards. Operations are not guaranteed with memory cards other than the following cards.

#### SxS PRO series

#### SxS-1 series

These cards comply with the ExpressCard standard.

*For details on using SxS memory cards and usage-related precautions, refer to the instruction manual for the SxS memory card.*

SxS, SxS PRO and SxS-1 are trademarks of Sony Corporation.

The ExpressCard word mark and logo are owned by Personal Computer Memory Card International Association (PCMCIA) and are licensed to Sony Corporation. All other trademarks are the property of their respective owners.

## Inserting/Removing an SxS Memory Card

### Inserting an SxS memory card

- 1 **Open the cover of the card slot block (page 16).**
- 2 **Insert the SxS memory card into the slot with the SxS label facing right.**  
The ACCESS lamp (page 16) lights in red then changes to green once the memory card is ready for use.
- 3 **Close the cover.**

#### Status indications by the ACCESS lamps

Card slots A and B are accompanied by the respective ACCESS lamps to indicate their statuses.

Lamp	Slot statuses
Lights in red	Accessing the loaded SxS memory card (writing/reading data)
Lights in green	Standby (ready for recording or playback using the loaded SxS memory card)
Off	<ul style="list-style-type: none"> <li>• No SxS memory card is loaded.</li> <li>• The loaded card is invalid.</li> <li>• An SxS memory card is loaded, but another slot is active.</li> </ul>

### Removing an SxS memory card

- 1 **Open the cover of the card slot block, press the EJECT button (page 16), then pull the button out.**
- 2 **Press the EJECT button again to remove the card.**

#### Note

Data are not guaranteed if the power is turned off or a memory card is removed while the card is being accessed. All data on the card may be destroyed. Be sure that the ACCESS lamps are lit in green or off when you turn off the power or remove memory cards.

## Switching Between SxS Memory Cards

When SxS memory cards are loaded in both card slots A and B, press the SLOT SELECT button (page 16) to select the card you wish to use. If a card becomes full during recording, switching to the other card is automatically executed.

### Note

The SLOT SELECT button is disabled while playback is in progress. Switching is not executed even if you press the button. The button is enabled while the thumbnail screen is displayed (page 63).

## Formatting an SxS Memory Card

For an SxS memory card that is not formatted or that was formatted with another system, the message “Unsupported File System” is displayed on the LCD monitor/EVF screen.

Format the card as instructed in “*To execute formatting*” below.

### To execute formatting

Using “Format Media” (page 99) in the OTHERS menu, specify “Media(A)” (slot A) or “Media(B)” (slot B) then select “Execute.” On a confirmation message, select “Execute” again.

The in-progress message and status bar (%) are displayed, and the ACCESS lamp lights in red. When formatting is completed, the completion message is displayed for three seconds.

### Recording/playback during formatting

You can perform recording or playback using the SxS memory card in the other card slot while formatting is in progress.

### If formatting fails

A write-protected SxS memory card or memory card that cannot be used with this camcorder will not be formatted.

As a warning message is displayed, replace the card with an appropriate SxS memory card, as per the instructions in the message.

### Note

All the data, including recorded pictures and setup files, are erased when a memory card is formatted.

## Checking the Remaining Time Available for Recording

While recording (or standing by to record), you can check the time remaining for the SxS memory cards loaded in the card slots on the LCD monitor/EVF screen (page 19).

The available time for recording with the current video format (recording bit rate) is calculated according to the remaining space of each card and displayed in time units of minutes.

The remaining can also be checked in a meter format on the Battery/Media status screen (page 76).

### Note

A  icon appears if the memory card is write-protected.

## Replacing an SxS memory card

- If the available time on two cards in total becomes less than 5 minutes, a message “Media Near Full,” flashing of the tally lamps, and a beep sound will warn you. Replace the cards with those with sufficient space.
- If you continue recording until the total remaining time reaches zero, the message changes to “Media Full,” and recording stops.

### Note

Approximately 600 clips can be recorded on one SxS memory card at maximum. If the number of recorded clips reaches the limit, the remaining time indication becomes “0,” and the message “Media Full” is displayed.

## Restoring an SxS Memory Card

If an error occurs with data in a memory card for some reason, the card must be restored.

If an SxS memory card that needs to be restored is loaded, a message that prompts you to execute a restore operation is displayed on the LCD monitor/EVF screen.

### To restore a card

Select “Execute” by pressing the up/down/left/right buttons or turning the jog dial, then push the SEL/SET button or the jog dial.

During restoration, the in-progress message and status bar (%) are displayed, and the ACCESS lamp is lit in red.

When restoration is completed, the completion message is displayed for three seconds.

### If restoration fails

- A write-protected SxS memory card or one on which an error occurred cannot be restored. For such a card, a warning message is displayed. Release the write protection or replace the card, as per the instructions in the message.
- An SxS memory card on which an error occurred may become usable again through repeated formatting.
- In some cases, only parts of clips cannot be restored. Playback of the restored clips becomes possible again.
- The following operation may restore an SxS memory card for which the message “Could not Restore Some Clips” is repeatedly displayed each time you try the restoration process:

- 1 Copy necessary clips to another SxS memory card, using the copy function (*page 69*) of the camcorder or the dedicated application software (supplied) (*page 105*).
- 2 Format the problem SxS memory card, using the format function of this camcorder.
- 3 Return the necessary clips to the SxS memory card by copy operation.

### Recording/playback during restoration

You can perform recording or playback using the SxS memory card in the other card slot while restoration is in progress.

#### Note

For restoration of media recorded with this unit, be sure to use this unit. Media recorded with a device other than this unit or with another unit of different version (even of the same model) may not be restored using this unit.

## Using an External Hard Disk

You can use an optional PHU-220R Professional Hard Disk Unit with this camcorder.

#### Notes

- High-speed playback (*page 15*) may not be properly achieved with a hard disk unit.
- Slow Motion recording by the Slow & Quick Motion recording function (*page 50*) cannot be made with a hard disk unit.
- The Hard Disk Unit does not support recording with UDF.

### Attaching/Removing the PHU-220R

Recording/playback can be made using the PHU-220R in the same manner as with SxS memory cards if you connect the PHU connection cable of the PHU-220R to an SxS memory card slot of the camcorder.

#### Mounting the hard disk unit on the camcorder

You can attach a hard disk unit to the front accessory shoe. By using the optional cold shoe kit (consisting of an auxiliary shoe, four screws, and a bottom plate) with the camcorder, you can also mount the hard disk unit on the rear accessory shoe (*page 14*) of the camcorder.

- 1 Place the auxiliary shoe on the rear accessory shoe and secure it with the four screws.

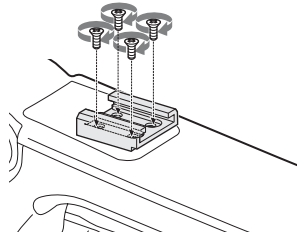

## 2 Fit the bottom plate (spring type) into the auxiliary shoe.

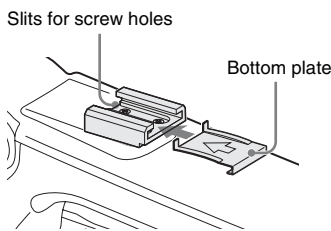

Insert the bottom plate from the end where the two slits for the screw holes of the auxiliary shoe are not open. If you secure the auxiliary shoe in the direction opposite that shown in the above figure with the slit open end forward, insert the bottom plate from the direction opposite to that shown in the figure.

## 3 Attach the shoe adapter (supplied with the PHU-220R) to the hard disk unit, mount the unit to the auxiliary shoe on the camcorder, and secure it with the lock lever of the shoe adapter.

For details, refer to the instructions supplied with the PHU-220R.

### Connecting the PHU connection cable

#### 1 Set the power switch to the ON position.

#### 2 Open the cover of the card slot block (page 16) and plug the PHU connection cable into a slot.

Insert the cable so that it points upward.

#### 3 Turn on the PHU-220R.

The POWER indicator of the PHU-220R lights in green.

Subsequently, the ACCESS lamp of the camcorder lights in red then changes to green once the unit is ready for use.

#### Notes

- The cover of the card slot block cannot be closed with the PHU-220R connected.
- Bundle the cable so that it will not accidentally get on nearby objects.

#### To disconnect the PHU connection cable

Operate in the same manner as when you remove an SxS memory card from the slot.

## Formatting the PHU-220R

For a PHU-220R that is not formatted or that was formatted with another system, the message “Unsupported File System” is displayed on the LCD monitor/EVF screen.

### To execute formatting

Using “Format Media” (page 99) in the OTHERS menu, specify “Media(A)” (slot A) or “Media(B)” (slot B) then select “Execute.”

An in-progress message and status bar (%) are displayed, and the ACCESS lamp lights in red. When formatting is completed, a completion message is displayed for three seconds.

#### Notes

- A format of the PHU-220R on this camcorder is performed as a quick format, in which only managerial data are erased. To erase the recording data completely, connect the PHU-220R to a PC and perform a full format.
- The PHU-220R to be used with this camcorder must be formatted using the format function of this camcorder.

## Checking the Remaining Time Available for Recording

While recording (or standing by to record), the remaining capacity (in minutes) of the PHU-220R connected via a card slot is displayed on the LCD screen/EVF screen (page 19).

The available time for recording with the current video format (recording bit rate) is calculated according to the remaining space of the hard disk and displayed in time units of minutes.

The remaining capacity can also be checked in a meter format on the Battery/Media status screen (page 76).

## Restoring the PHU-220R

If an error occurs with data on the PHU-220R for some reason, the hard disk must be restored.

If a PHU-220R that needs to be restored is connected, a message that prompts you to execute restoration is displayed on the LCD monitor/EVF screen.

---

## To restore the hard disk

---

Select “Execute” via the up/down/left/right buttons or the jog dial, then press the SEL/SET button or the jog dial.

During restoration, an in-progress message and status bar (%) are displayed, and the ACCESS lamp is lit in red.

When restoration is completed, a completion message is displayed for three seconds.

### If restoration fails

- A PHU-220R on which an error occurred may become usable again through reformatting.
- In some cases, only parts of clips cannot be restored. Playback of the restored clips becomes possible again.

## Using Other Media

### XQD Memory Cards

By using an optional QDA-EX1 Media Adaptor, you can insert an XQD memory card into the SxS memory card slot and use it instead of an SxS memory card.

#### Usable XQD memory cards

QD-H16, QD-H32 (as of March 2012)

*For details on using a QDA-EX1 Media Adaptor, refer to the instruction manual supplied with it.*

#### Notes

- High-speed playback (*page 15*) may not be properly achieved with an XQD memory card.
- Slow Motion recording by the Slow & Quick Motion recording function (*page 50*) cannot be made with an XQD memory card.
- Not all XQD memory cards are guaranteed to work with this camcorder. For compatible memory cards, contact your dealer.

---

### Formatting

---

When you use an XQD memory card with this camcorder, formatting is required.

An XQD memory card to be used with this camcorder must be formatted using the format function of this camcorder.

It is also necessary to format an XQD memory card for use if a caution message is displayed when you mount the XQD memory card.

For an XQD memory card that was formatted with another system unsupported by this camcorder, the message “Unsupported File System” is displayed on the LCD monitor/EVF screen.

Format the XQD memory card as instructed below.

#### To execute formatting

Using “Format Media” (*page 99*) in the OTHERS menu, specify “Media(A)” (slot A) or “Media(B)” (slot B), then select “Execute.”

An in-progress message and status bar (%) are displayed, and the ACCESS lamp lights in red. When formatting is completed, a completion message is displayed for three seconds.

**Note**

When formatting, all data in an XQD memory card—including protected images—are erased and cannot be restored.

**Connection between the camcorder and a PC**

To use an XQD memory card in which data have been recorded with an XDCAM/XDCAM EX-series product, insert it into the slot of the camcorder and connect between the PC and this camcorder using a USB cable.

**To use media formatted with this camcorder in the slots of other devices**

Make a backup of the media, then format it using the other device.

**“Memory Stick” media/SDHC Cards**

Use of the optional MEAD-MS01 or MEAD-SD01 Media Adaptor permits you to insert a “Memory Stick” or an SDHC card to the SxS memory card slot and use it for recording and playback in the same way as with an SxS memory card.

**Usable “Memory Stick”**

“Memory Stick PRO-HG Duo” HX series

**Usable SDHC card**

Class 10 SDHC card

*For details on use of the MEAD-MS01/SD01 Media Adaptor, refer to the operating instructions supplied with the respective adaptor.*

**Notes**

- High-speed playback (*page 15*) may not be properly achieved with a “Memory Stick” or an SDHC card.
- Slow Motion recording by the Slow & Quick Motion recording function (*page 50*) cannot be made with a “Memory Stick” or an SDHC card.
- “Memory Stick” media and SDHC cards do not support recording with UDF.

**Formatting**

When you use a “Memory Stick” or an SDHC card with this camcorder, formatting is required. A “Memory Stick” or an SDHC card to be used with this camcorder must be formatted using the format function of this camcorder.

It is also necessary to format a “Memory Stick” or an SDHC card for use if a caution message is displayed when you mount the “Memory Stick” or SDHC card.

For a “Memory Stick” or an SDHC card that was formatted with another system unsupported by this camcorder, the message “Unsupported File System” is displayed on the LCD monitor/EVF screen.

Format the “Memory Stick” or SDHC card as instructed below.

**To execute formatting**

**Using “Format Media” (*page 99*) in the OTHERS menu, specify “Media(A)” (slot A) or “Media(B)” (slot B), then select “Execute.”**

An in-progress message and status bar (%) are displayed, and the ACCESS lamp lights in red. When formatting is completed, a completion message is displayed for three seconds.

**Note**

When formatting, all data in a “Memory Stick” or an SDHC card including protected images are erased and cannot be restored.

**Connection between the camcorder and a PC**

To use a “Memory Stick” or an SDHC card in which data have been recorded with an XDCAM/XDCAM EX-series product, insert it into the slot of the camcorder and connect between the PC and this camcorder using a USB cable.

**To use media formatted with this camcorder in the slots of other devices**

Make a backup of the media, then format it using the other device.

**USB Flash Drives (PMW-200 only)****UDF**

In UDF mode, you can connect a USB flash drive to the external device connector (*page 17*) to record, save and load the following data.

- “Loading a Planning Metadata file” (*page 60*)
- “Storing/Retrieving the Setting Data” (*page 59*)

The following Sony USB flash drives are recommended for use with this camcorder.

**Pocket Bit Hi-Speed LX Series**

- USM32GLX
- USM16GLX
- USM8GLX
- USM4GLX (available in Japan only)

**Notes**

- Use USB flash drives with a capacity of 4 GB to 32 GB.
- USB flash drives other than those listed above may not be recognized if connected to the external device connector.

---

## Formatting (Initializing) USB Flash Drives

---

USB flash drives must be formatted with the FAT32 file system.

**Note**

Before using a drive, format it on this camcorder or a PC. If a drive formatted on a PC cannot be used, format it on the camcorder.

### 1 Connect a USB flash drive to the external device connector.

If the drive is unformatted or has been formatted to other specifications, a message to confirm whether formatting is to be executed appears on the viewfinder screen.

### 2 Using the up/down/left/right buttons or the jog dial, select “Execute,” then press the SEL/SET button or the jog dial.

When formatting is completed, the message “Format USB Memory Done” is displayed. The \MSSONY\PROXD\CAM\MEMDISC folder and the \General\Sony\Planning folder are automatically created in the drive.

#### If the format operation fails

A format operation may fail because the USB flash drive is write protected, or because it is not the type of drive specified for use with this camcorder.

In this case, an error message appears. Follow the instructions in the error message and exchange the drive for one that can be used with this camcorder.

---

## Restoring USB Flash Drives

---

When you load a USB flash drive that cannot be mounted normally because the file system is destroyed, a message appears on the viewfinder screen to ask whether you want to restore it. Using the up/down/left/right buttons or the jog dial, select “Execute,” then press the SEL/SET button or the jog dial. Formatting starts and a progress (%) indication appears.

When formatting is completed, the message “Format USB Memory Done” is displayed.

- |   |
|---|
| <ul style="list-style-type: none"> <li>• “Memory Stick” and  MEMORY STICK are trademarks of Sony Corporation.</li> <li>• “Memory Stick PRO-HG Duo” and MEMORY STICK PRO-HG DUO are trademarks of Sony Corporation.</li> <li>• “XQD” is a trademark of Sony Corporation.</li> </ul> |
|---|

## Using a Wi-Fi Adapter (PMW-200 only)

Mounting an optional CBK-WA01 Wi-Fi Adapter on this camcorder allows a Wi-Fi connection between a computer and the camcorder.

For details about the CBK-WA01, refer to the *Mounting Instructions and Operating Instructions* supplied with the CBK-WA01.

Making a Wi-Fi connection between a computer and the camcorder enables you to do the following.

- Send planning metadata created on a computer to the camcorder, and set names of clips to shoot and shot marks for shooting.
- Send files including clips from the camcorder to a computer, and edit them at the shooting location.

## Fixing the CBK-WA01

### Notes

- Before attaching or removing the CBK-WA01, turn the power of the camcorder off.
- It may be impossible to stow the camcorder attached with the CBK-WA01 in a carrying case.

- 1 Remove the two screws from the handle, place the Wi-Fi adapter fixing bracket in the desired position, then fix the bracket with the removed two screws.**

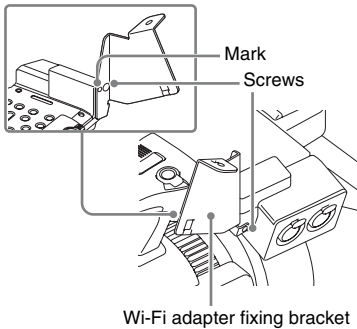

Wi-Fi adapter fixing bracket

- 2 Insert the protrusion on the back of the CBK-WA01 into the hole on the Wi-Fi adapter fixing bracket, and tighten the screw to fix the CBK-WA01 to the bracket.**

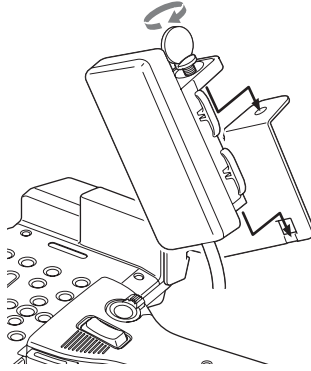

- 3 Loosen the screws, remove the cover of the external device connector, then connect the cable of the CBK-WA01.**

External device connector

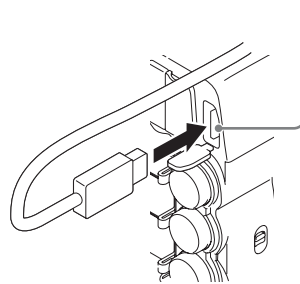

### When you use an external microphone

Use the supplied microphone cable holder if necessary.

Attach the microphone cable holder by adjust with the mark, and fix it with the screws for mounting the microphone cable holder.



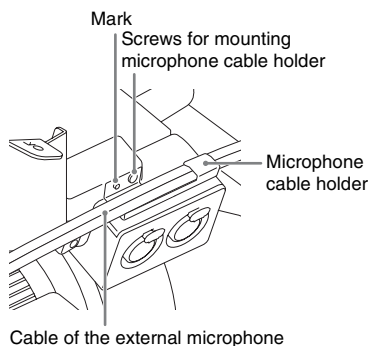

## Making a Wi-Fi Connection

Two types of Wi-Fi connections are available. In “ad-hoc mode”, you can make a peer-to-peer Wi-Fi connection between a computer and camcorder. In “infrastructure mode”, you can make Wi-Fi connections between a computer and multiple camcorders via a wireless LAN access point (building a LAN).

### To make a network setting

Change settings under OTHERS >Network in the setup menu as required.

Item	Setting
DHCP	Setting that specifies whether to acquire the IP address automatically from a DHCP server Enabled: Acquire automatically. <b>Disabled:</b> Do not acquire automatically (factory default setting).
IP Address	IP address <sup>a)</sup> (factory default setting: 192.168.1.10)
Subnet Mask	Subnet mask (factory default setting: 255.255.255.0)
Default Gateway	Default gateway (factory default setting: 0.0.0.0)
User Name	User name for log-in (factory default setting: admin)
Password	Password for log-in (factory default setting: model name “pmw-200”)

a) The IP address determined by DHCP server is displayed here.

### When you have changed a setting

Set the Set item to [Execute]. When a confirmation message appears, turn the MENU knob to select “Execute” and press the knob.

### To make a connection in ad hoc mode

**1** Refer to “Settings on the Computer” under “Making a Wi-Fi Connection to Your Computer (Ad hoc Mode)” in the Operating Instructions supplied with the CBK-WA01 to make settings on the computer.

**2** Start a connection on the computer.

**3** Set OTHERS >Wi-Fi >Wi-Fi to [Enable] in the setup menu.

**4** Set OTHERS >Wi-Fi >Scan Networks to [Execute] and press the SEL/SET button.

The camcorder starts scanning for a network connection.

When networks are detected, the NETWORK SCAN list appears.

**5** Turn the up/down/left/right buttons to select a network and press the SEL/SET button.

The OTHERS menu appears again.

**6** Confirm that the settings for the Wi-Fi item conform to the network setting on the computer.

**SSID (network name):** Selected network name

**Network Type (connection mode):** Adhoc  
**CH (channel):** 1

**Authentication (network authentication):**  
Depending the settings on the computer, Open, Shared or WPA

**Encryption (data encryption):** Depending the settings on the computer, Disable, WEP, TKIP or AES

**WEP Key Index (key index):** 1 when Encryption is set to [WEP]

**Input Select (key input format):** Depending the network key (or security key), ASCII5, ASCII13, HEX10 or HEX26 when Encryption is set to [WEP], ASCII8-63 or HEX64 Encryption is set to [TKIP] or [AES]

**7** Set the Key item to the network key (or security key) set on the computer and press the SEL/SET button.

## 8 Set the Set item to [Execute] and press the MENU knob.

The message “Wi-Fi Setting Executing...” appears and the camcorder starts connection. If the connection to the computer is complete, then the message changes to “Wi-Fi Setting OK”.

Black squares appear in the Wi-Fi Status column to show the connection status. (The number of squares shows the level of connection status.) In the Wireless Mode column, the IEEE802.11 standard of the established connection appears (802.11b, 802.11g or 802.11n).

### Tip

It is also possible to make a connection by accessing a network connection started on the camcorder from the computer.

### To terminate the connection

Terminate the connection on the computer.

### To revert to the default settings (reset)

If you have trouble making a connection, or you want to start over, you can reset your Wi-Fi connection settings to their defaults.

Set OTHERS >Network >Net Config Reset in the setup menu to “Execute” and press the SEL/SET button.

If the reset is executed, the message “Net Config Reset Done” appears.

The camcorder attempts to connect to the network using a MAC address as the SSID.

## To make a connection in infrastructure mode

### Setting up the wireless LAN access point

The following settings are required.

- Network ID (SSID)
- Encryption method
- Network key (Key)

*For details about setting up the wireless LAN access point.*

### To find and connect to a wireless LAN from the camcorder

Perform the same procedure in “To make a connection in ad hoc mode” (page 33) excluding the following.

- Do not perform steps 1 and 2.
- The settings made in step 7 change as follows.

**SSID (network name):** Selected network connection name

**Network Type (connection mode):** Infra

**Ch (channel):** Auto

**Authentication (network authentication):**

Depending the settings on the computer, Open, Shared, WPA or WPA2

**Encryption (data encryption):** Depending the settings on the computer, Disable, WEP, TKIP or AES

**WEP Key Index (key index):** 1 when Encryption is set to [WEP]

**Input Select (key input format):** Depending the network key (or security key), ASCII5, ASCII13, HEX10 or HEX26 when Encryption is set to [WEP], ASCII8-63 or HEX64 Encryption is set to [TKIP] or [AES]

## Using the Web Menu

You can operate the Web menu built in the camcorder from a computer when it is connected to the camcorder via a Wi-Fi connection.

### Example Web menu

#### Product Information

- Model name
- Serial No.

#### Network

- MAC Address
- IP Address
- Subnet Mask

#### Wi-Fi Status

- Wireless Mode
- SSID
- Type
- Channel
- Authentication (network authentication)
- Data Encryption (data encryption)

#### Planning Metadata

Clicking “Upload” displays the Planning Metadata screen which allows upload of a planning metadata file (page 35).

#### Note

The configuration of items displayed in the Web menu varies depending on the browser you are using.

---

## To display the Web menu

---

- 1 Launch a browser on the computer, and navigate to “http://<camcorder’s IP address> (setting of OTHERS >Network >IP Address in the setup menu)”.**

**Example (when the IP address is “192.168.1.10”):** Type “http://192.168.1.10/” in the address bar.

If the connection is complete, a dialog appears asking you to enter the user name and password.

- 2 Enter the user name and password, and click [OK].**

**User name:** admin

**Password:** pmw-200 (Lower-case the model name.)

---

## To upload a planning metadata file

---

- 1 Insert a media such as an SxS memory card.**
- 2 Click “Upload” in the Web menu.**  
The Planning Metadata screen appears.
- 3 Click “Select” to show Choose File dialog.**
- 4 Select the planning metadata file you want to upload, and then click “Open”.**  
The path of the selected file appears.
- 5 Click “Execute”.**

The planning metadata file is loaded into the camcorder’s memory and stored in the media.

“OK” appears in the Status field when the transfer is complete.

# Basic Operation Procedure

## 4 Preparing the lens cap

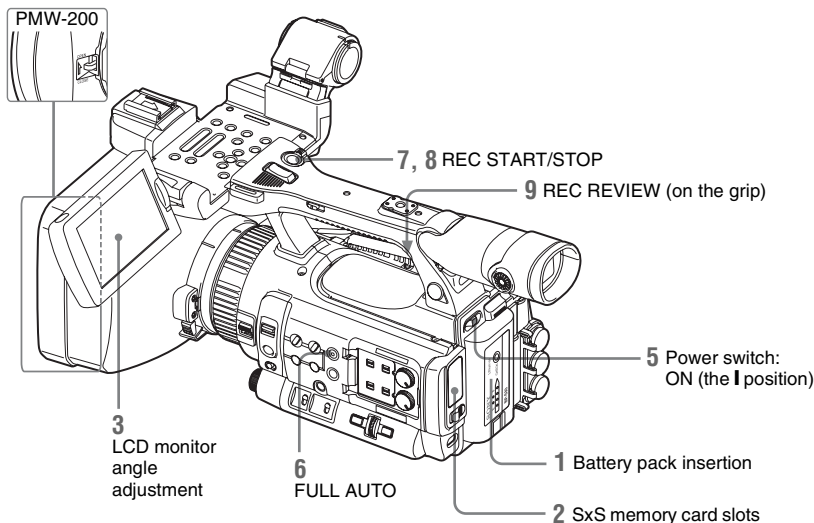

## Preparations

- 1 Mount a fully charged battery pack.**
- 2 Load SxS memory card(s).**  
If you load two cards, recording is continued by automatically switching to the second card when the first card becomes full.
- 3 Adjust the angle of the LCD monitor for the best view.**  
When you wish to use the EVF, fold the LCD monitor to its park position and adjust the angle of the EVF.
- 4 Open the lens cap./Remove the lens cap.**  
**PMW-200**  
Pull up the lens cap open/close lever to open the lens cap built in the lens hood.  
**PMW-100**  
Remove the lens cap.
- 5 Set the power switch to the ON position.**  
The recording screen is displayed.

When using the remote commander, activate the remote control mode (*page 24*).

### Note

When you hold the camcorder by the grip, support it from underneath with your left hand.

## Recording (Full Auto mode)

- 6 Press the FULL AUTO button so that the button indicator lights.**  
Full Auto mode is turned on, activating the TLCS (Total Level Control System) (*page 84*). Auto Iris (PMW-200)/Auto Exposure (PMW-100), AGC (Auto Gain Control), Auto Shutter, ATW (Auto Tracing White) are set to ON, consequently the brightness and white balance will be automatically adjusted.  
When you wish to adjust them manually, turn Full Auto mode off, and see;  
“Iris (PMW-200) / Exposure (PMW-100)” on *page 41*  
“Gain” on *page 40*  
“Electronic Shutter” on *page 40*

“White Balance” on page 39

#### Note

AF (Auto Focus) is not activated by setting the camcorder to Full Auto mode.

For information of automatic focus adjustment, see “Focus” (page 42).

## 7 Press the REC START/STOP button.

You can also start recording with the REC START button on the grip.

(If you are using the IR Remote Commander, press the REC button simultaneously with the unmarked button.)

The front and rear tally lamps light and recording begins.

## 8 To stop recording, press the REC START/STOP button again.

You can also stop recording with the REC START button on the grip.

(If you are using the IR Remote Commander, press the REC PAUSE button simultaneously with the unmarked button.)

Recording stops and the camcorder enters STBY (recording standby) mode.

#### Note

If you press the REC START/STOP button to start next recording while previous data writing is not completed, the message “Cannot Proceed” may be displayed and recording may not start.

### To prevent a switching error

The REC START/STOP button on the handle is incorporated with the REC HOLD lever. If the REC START/STOP button on the handle will not be used, it is recommended to set the lever to the HOLD position to lock the button and prevent unintentional starting/stopping of recording if you accidentally press the button.

To unlock the button, return the lever to its original position.

## Checking the last recorded clip (Rec Review)

## 9 Press the REC REVIEW button.

The Rec Review function (page 47) is activated, and the last recorded clip is played back for the specified time on the LCD monitor/EVF screen.

## To delete clips

You can delete the last recorded clip by using the Last Clip DEL function (page 59). Use the All Clips DEL function (page 59) to delete all recorded clips from an SxS memory card. To specify a clip to be deleted, operate the camcorder from the thumbnail screen (page 63).

### Clip (recording data)

When you stop recording, video, audio and subsidiary data from the start to end of the recording are recorded as a single clip on an SxS memory card.

### Clip name

For each clip recorded with this camcorder, a clip name is automatically generated according to the method selected with “Auto Naming” in “Clip” (page 98) in the OTHERS menu.

The default setting of “Auto Naming” is “Plan.” With this setting, a clip name defined in planning metadata is applied if a planning metadata file is loaded into the camcorder. Change the “Auto Naming” setting to “Title” to apply a clip name composed of 4 to 46 alphanumeric and 4 numerics.

### Example: ABCD0001

The block of 4 to 46 alphanumeric can be specified as desired using “Clip” in the OTHERS menu before you start recording. (It cannot be changed after recording.)

The value of the 4 numerics is automatically counted up in sequence.

### Notes on Clips

The maximum file size for a clip is 43 GB for UDF, 4 GB for FAT in HD Mode, and 2 GB for FAT in SD Mode. If you continue recording for an extended period, recorded materials may be segmented into multiple files, depending on the file size (the maximum number of partitions is 99). The camcorder regards continuous recording as one clip even if it has been segmented into multiple files.

A long clip can be recorded crossing over two memory cards in slot A and B.

When you copy recorded clips to a hard disk drive, etc. using a computer, it is recommended to use the dedicated application software on the supplied CD-ROM.

#### Note

If copying is done using Explorer (Windows) or Finder (MAC), the continuity and relationships of recorded materials may not be maintained.

**Maximum duration of a clip**

The maximum clip length is 24 hours for FAT (MP4 or AVI) and 6 hours for UDF (MXF).

If you exceed the maximum clip length, a new clip will be automatically created. You can check the new clip on the thumbnail screen.

## Changing Basic Settings

You can make changes to the settings based on the intended usage of the recorded video or recording conditions.

### Video Formats

Selectable formats vary depending on the UDF/FAT, HD Mode/SD Mode, and usage region (NTSC Area/PAL Area) settings.

*You can change the usage area by setting “Country” in “System” (page 97) in the OTHERS menu.*

### Switching between UDF/FAT

Switch by setting “UDF”/“FAT” in “System” (page 97) in the OTHERS menu.

After switching this setting, the camcorder will automatically restart.

**Note**

UDF/FAT cannot be switched during recording or playback.

### Switching between HD Mode/SD Mode

For HD/SD switching, use “System” (page 97) in the OTHERS menu.

When you change the menu setting, the camcorder automatically restarts, executing the switching.

**Note**

HD/SD switching is disabled during recording and playback.

### Changing the format

To change the format, use “Format” in “System” (page 97) in the OTHERS menu.

Signals from the SDI OUT, A/V OUT, and HDMI OUT connectors are also output according to the format selected with this menu.

### ND Filter (PMW-200 only)

ND filters are available for keeping the aperture in a proper range.

2:  $\frac{1}{64}$ ND

1:  $\frac{1}{8}$ ND

**Clear:** ND filter not used

## White Balance

You can select the adjustment mode according to the shooting conditions.

### Preset mode

The color temperature is adjusted to the preset value (factory setting: 3200K) in this mode. Select this mode when there is no time to adjust the white balance or when you wish to fix the white balance to the condition of you set for a Picture Profile.

### Memory A mode, Memory B mode

The white balance is adjusted to the value stored in memory A or memory B.

Pressing the WHITE BAL button executes auto white balance and stores the adjusted value in memory A or memory B.

### ATW (Auto-Tracing White balance) mode

In this mode, the camcorder automatically adjusts the white balance to the appropriate condition.

When the color temperature of the light source changes, the white balance adjustment is automatically executed.

Five steps of adjustment speed can be selected with "ATW Speed" (page 85) in the CAMERA SET menu.

When the ATW Hold function is assigned to an assignable button (page 48), you can momentarily hold the ATW value to fix the white balance, even in ATW mode, by pressing the button.

#### Note

When NightShot mode is set to "On," ATW cannot be set. (PMW-100 only)

## Using the switch

Make a selection with the WHITE BAL switch (page 16).

**B:** ATW mode or Memory B mode

**A:** Memory A mode

**PRST:** Preset mode

The B position of the WHITE BAL switch is assigned to ATW mode at the factory. The setting can be changed with "White Switch <B>" (page 84) in the CAMERA SET menu to select Memory B mode.

Setting the camcorder to Full Auto mode (page 36) forcibly activates ATW mode.

Assigning the ATW on/off function to an assignable button (page 48) permits you to independently activate/deactivate ATW when Full Auto mode is off.

## Using the Direct menu

When you press the DISPLAY button (page 15), the current adjustment mode and color temperature are displayed on the screen (page 19).

**ATW:** ATW mode

**W:A:** Memory A mode

**W:B:** Memory B mode

**W:P:** Preset mode

**W:NS:** NightShot mode "On" (PMW-100 only)

When the Direct menu (page 20) is in All mode, you can select from among ATW, W:A, W:B, and W:P.

When the Direct menu is in Part mode, you can switch between ATW and the mode set with the WHITE BAL switch.

When W:NS is displayed, switching via the Direct menu is not possible.

## Executing Auto White Balance

- To store the adjustment value in memory, select Memory A or Memory B mode.**
- Place a white subject under the same lighting condition and zoom in on it so that a white area is obtained on the screen.**
- Adjust the brightness.**
- Press the WHITE BAL button (page 16).**

Auto white balance adjustment begins.

When you execute the adjustment in a memory mode, the adjusted value is stored in memory (A or B) selected in step 1.

When you execute the adjustment in ATW mode, adjustment in ATW is resumed.

#### Notes

- Auto white balance adjustment cannot be performed when in Preset mode.

- When NightShot mode is set to “On,” auto white balance cannot be performed. (PMW-100 only)
- If auto white balance adjustment fails, an error message is displayed on the screen for approximately 3 seconds. If the error message continues to be displayed after several attempts, consult your Sony service representative.

## Markers/Zebra Patterns

During recording, various markers and zebra patterns can be inserted into the image on the LCD monitor/EVF screen.

This does not affect recording signals.

### Displaying the Markers

Use “Marker” (*page 90*) in the LCD/VF SET menu.

### Displaying the Zebra Patterns

A zebra pattern(s) can be inserted to the picture on LCD monitor/EVF screen to check the appropriate luminance level.

Pressing the ZEBRA button (ASSIGN 1 button) (*page 16*) turns the zebra pattern-indication on/off.

### Changing the zebra pattern

Using “Zebra” (*page 90*) in the LCD/VF SET menu, you can change the zebra pattern to be displayed.

## Gain

### Recording with Fixed Gain

You can change the gain of the video amplifier.

#### Selecting the gain with the switch

The gain value at each of the GAIN switch (*page 16*) positions set at the factory are as follows:

**L:** 0 dB

**M:** 9 dB

**H:** 18 dB

These values can be changed in the range of -3 dB to +18 dB, using the CAMERA SET menu’s Gain Setup menu (*page 80*).

#### Note

You cannot select a fixed gain when AGC mode is set to On.

### Selecting gain using the Direct menu

When you press the DISPLAY button (*page 15*), the current gain value is displayed on the screen (*page 19*).

When the Direct menu is in All mode, you can change the gain in steps of 3 dB with the Direct menu.

You can also select AGC mode with the Direct menu.

When the Direct menu is in Part mode, you can switch between only AGC mode and the gain selected with the GAIN switch.

### Recording in AGC Mode

The gain of the video amplifier is automatically adjusted according to the picture brightness.

When you set the camcorder to Full Auto mode (*page 36*), AGC mode is forcibly selected.

When Full Auto mode is off, you can independently turn AGC mode on by setting “AGC” in “TLCS” (*page 84*) in the CAMERA SET menu to “On,” or selecting “AGC” with the Direct menu.

## Electronic Shutter

### Recording with a fixed shutter

Set the shutter speed (cache time).

When you set the SHUTTER switch (*page 16*) to ON, the fixed shutter is turned on in the mode and with the shutter speed you specified with “Shutter” (*page 80*) in the CAMERA SET menu.

#### Note

- When Auto Shutter mode is ON, the fixed shutter cannot be selected.
- When the SLS/EX SLS mode (*page 41*) is ON, the fixed shutter cannot be selected.

#### Setting with the CAMERA SET menu

The shutter mode and shutter speed can be set with “Shutter” (*page 80*) in the CAMERA SET menu.

#### Setting with the Direct menu

When you press the DISPLAY button, the current shutter mode and the set value are displayed (*page 19*).

When the Direct menu (*page 20*) is in All mode, you can change the shutter mode and speed with the Direct menu.



## Notes

- When the Direct menu is in Part mode, you cannot turn the shutter on/off with the Direct menu if the SHUTTER switch is set to ON.  
If the SHUTTER switch is set to OFF, you can switch only between Auto Shutter and Shutter OFF.
- The Direct menu cannot be selected when Full Auto mode is turned on (page 36) or when the SLS/EX SLS mode is set.

## Shooting in SLS/EX SLS Mode

The shutter speed is specified in the number of accumulated frames. Up to 64 frames can be accumulated in this mode, permitting you to obtain low-noise clear pictures in low light levels or surreal pictures with afterimages.

PMW-200: For SLS, set “Mode” to “SLS” with “Shutter” (page 80) in the CAMERA SET menu and specify the number of accumulated frames with “SLS Frame.” You can select in the range of 2 to 8 frames.

When Full Auto mode (page 36) is ON or Auto Shutter mode is ON, SLS cannot be set.

For EX SLS, set “Setting” to “On” with “EX Slow Shutter” (page 80) in the CAMERA SET menu and specify the number of accumulated frames with “Number of Frames.” You can select from among 16, 32, and 64 frames.

When also Full Auto mode (page 36) is ON or Auto Shutter mode is ON, EX SLS can be set.

PMW-100: Select “SLS/EX SLS” (page 81) in the CAMERA SET menu and set the number of accumulated frames. For EX SLS, set 16, 32, or 64.

This can also be set when Full Auto mode (page 36) is turned on.

## Shooting in Auto Shutter Mode

The shutter speed is automatically adjusted according to the picture brightness.

When you set the camcorder to Full Auto mode (page 36), Auto Shutter is forcibly selected.

When Full Auto mode is off, you can independently turn Auto Shutter mode on by setting “Auto Shutter” in “TLCS” (page 84) in the CAMERA SET menu to “On.”

## Iris (PMW-200) / Exposure (PMW-100)

Adjust the brightness according to the subject.

## Recording in auto mode

### When Full Auto mode (page 36) is set to ON:

Iris (PMW-200) or Exposure (PMW-100) is forcibly set to Auto mode.

### When Full Auto mode is set to OFF:

PMW-200: When the IRIS switch is set to AUTO, Auto Iris mode is set.

PMW-100: You can turn it on by setting “Exposure” (page 85) in the CAMERA SET menu to “Auto.” You can also set “Auto”/ “Manual” for “Exposure” to an assignable button (page 48).

You can select the target level (to make the picture darker or brighter) for Auto Iris (PMW-200) or Exposure (PMW-100) via the Setup menu or Direct menu. (The gain control in AGC mode and the shutter speed control in Auto Shutter mode are adjusted in synchronization.)

### To adjust the target level with the Setup menu

Set “Level” in “TLCS” (page 84) in the CAMERA SET menu.

### To adjust the target level with the Direct menu

The target level can also be selected using the Direct menu (page 20). When you press the DISPLAY button, the current Exposure position is displayed on the screen (page 19).

## Adjusting the brightness manually

PMW-200: When Full Auto mode is set to OFF, setting the IRIS switch to MANUAL sets to Manual Iris mode. Rotate the iris ring for the desired iris opening.

PMW-100: When Full Auto mode is set to OFF, set “Exposure” (page 85) in the CAMERA SET menu to “Manual” to use Manual mode. When Manual mode is set, rotate the EXPOSURE dial (page 13) to adjust the brightness. (Rotate the dial clockwise while facing the front of the camcorder to increase the brightness.) You can turn Manual mode on/off by pressing the EXPOSURE button (page 13).

## Zoom

### Operating Zoom manually

PMW-200: Setting the ZOOM switch (page 17) on the bottom of this unit to the MANUAL position sets to manual zoom mode.

PMW-100: Setting the FOCUS/ZOOM switch (page 13) to the ZOOM position activates ZOOM adjustment via the lens operation ring (page 13).

---

## Using the Power Zoom

---

The power zoom lever (page 17) on the grip and the handle ZOOM button (page 15) are activated. The current zoom position is displayed on the screen in the range of 0 (Wide) to 99 (Tele) when you press the DISPLAY button. The supplied IR Remote Commander and optional lens remote control unit (PMW-200 only) can also be used.

PMW-200: Setting the ZOOM switch on the bottom of this unit to the SERVO position sets to power zoom mode.

PMW-100: You can always operate the power zoom.

The numerical indication can be changed to that in a bar by changing “Zoom Position” in “Display On/Off” (page 90) in the LCD/VF SET menu.

**To adjust with the power zoom lever on the grip**  
Pressing the lever deeper sets zooming faster.

### To adjust with the handle ZOOM button

Zooming is activated at the speed selected with the speed switch (page 15).

The zoom speed assignment can be changed with “Zoom Speed” (page 82) in the CAMERA SET menu.

You can select Soft mode for zooming by using “Zoom Transition” (page 82) in the CAMERA SET menu, in which the zooming speed is gradually increased at the beginning then gradually decreased for the end.

### When adjusting with the ZOOM button of the IR Remote Commander

The zooming speed depends on the “Remote” (page 82) setting in “Zoom Speed” in the CAMERA SET menu.

To use the IR Remote Commander, see “Using the IR Remote Commander” (page 24).

---

## When using a lens remote controller (PMW-200 only)

---

Zooming can also be controlled from an optional lens remote controller connected via the LENS REMOTE connector.

For operation, refer to the operation guide of the lens remote controller.

## Focus

The infinity ( $\infty$ ) position has some margin to compensate for focus change caused by variation in ambient temperature. When shooting an image at infinity in MF mode, adjust the focus while observing the image on the LCD monitor/EVF screen.

---

## Adjusting in Full MF Mode (PMW-200 only)

---

Pull the focus ring rearward (toward the camcorder body) to set the camcorder to Full MF mode. Focus can only be adjusted with the focus ring manually.

### Note

The focus instantly moves to the range index position when you pull the focus ring rearward.

Rotate the focus ring for the best focus while observing the picture on the LCD monitor/EVF screen.

The range index of the focus ring is effective in Full MF mode. The distances correspond to the focus ring positions.

### Expanded Focus

When you press the EXPANDED FOCUS button, the center area of the picture is magnified on the LCD monitor/EVF screen, making the focus adjustment easier.

Press the EXPANDED FOCUS button again or leave the focus ring unmoved for 5 seconds to resume the normal angle for recording.

### Peaking

When you press the PEAKING button, the peaking function is activated. This function emphasizes the contours of the images on the LCD monitor/EVF screen, making manual focusing easier.

This function does not affect recording signals. The emphasis level and color of the contours can be set with “Peaking” (page 89) of the LCD/VF SET menu.

---

## Adjusting in MF Mode

---

MF (Manual Focus) mode allows you to activate Auto Focus momentarily when required.

PMW-100: Set the FOCUS/ZOOM switch (*page 13*) to FOCUS and the FOCUS switch (*page 16*) to MANUAL.

PMW-200: Slide the focus ring forward (to lens hood side), then set the FOCUS switch (*page 15*) to MANUAL.

In this mode, expanded focus function, peaking function, one-push auto focus function and the MF Assist function are activated.

Rotate the lens operation ring (PMW-100) or focus ring (PMW-200) while looking at the LCD monitor/EVF screen to adjust the focus.

### One-Push (Momentary) Auto Focusing

When you press the PUSH AF button, auto focusing momentarily activates. One-Push Auto Focusing is terminated when the subject comes into focus.

### MF Assist function

If you set “MF Assist” (*page 81*) in the CAMERA SET menu to “On” to enable the MF Assist function, auto focusing is engaged when you stop rotating the lens operation ring, performing fine focus adjustment for the subject in the center of the screen. When the fine adjustment is completed, automatic focusing with the MF Assist function is terminated.

You can also enable the MF Assist function via the Direct menu (*page 20*). When you press the DISPLAY button, the selected focus mode is displayed on the screen (*page 19*). The Direct menu cannot be selected in a mode other than MF mode.

---

## Adjusting in AF Mode

---

AF (Auto Focus) mode adjusts the focus automatically.

PMW-100: Set the FOCUS switch (*page 16*) to AUTO.

PMW-200: Slide the focus ring forward, then set the FOCUS switch to AUTO.

---

## Using Macro Mode (PMW-200 only)

---

When you set the MACRO switch to ON in AF or MF mode, Macro mode is activated, permitting you to adjust the focus in a range that includes the micro area.

The Macro mode is invalid in Full MF mode.

## Steady Shot

Set “Steady Shot” (*page 85*) in the CAMERA SET menu to “On.”

When you press the DISPLAY button, the setting of the Steady Shot function is displayed on the screen (*page 19*). The Steady Shot function can also be activated via the Direct menu (*page 20*).

### Note on use of a wide-conversion lens

Two operation modes are provided for Steady Shot: Normal mode and Wide mode (for a wide-conversion lens).

When you attach the optional wide-conversion lens, be sure to set “Wide Conversion” (*page 85*) in the CAMERA SET menu to “On.”

### Note

If the camcorder is fixed to a tripod, etc., for stability, deactivate the Steady Shot function.

## NightShot (PMW-100 only)

NightShot is convenient for recording in dark areas.

Set “Setting” in “NightShot” (*page 85*) in the CAMERA SET menu to “On.”

You can also assign NightShot to an assignable button (*page 48*) to change value of “Setting” to “On”/“Off.”

### To emit an infrared line

Set “NS Light” in “NightShot” (*page 85*) in the CAMERA SET menu to “Auto” to automatically emit an infrared line from the IR transmitter (*page 14*).

### Notes

- Avoid covering the IR transmitter with your finger when using the NightShot infrared line
- The infrared line can reach to about 3 meters.
- If the image is out of focus, adjust the focus manually.
- Using this in a bright area may damage the camcorder.
- When you set the camcorder’s power switch to “OFF,” NightShot is automatically disabled.

## Flickers

### Setting the shutter speed according to the power-supply frequency

Activate the electronic shutter (*page 40*) and set the shutter speed according to the power supply frequency.

#### When the frequency is 50 Hz

Set the shutter speed to 1/50 or 1/100 seconds.

#### When the frequency is 60 Hz

Set the shutter speed to 1/60 or 1/120 seconds.

### Using the Flicker-Reduction function

Set “Mode” in “Flicker Reduce” (*page 82*) in the CAMERA SET menu to “Auto” or “On” and set “Frequency” to the power-supply frequency (50 Hz or 60 Hz).

#### Note

If the frame rate selected for recording is close to the power-supply frequency, flicker may not be reduced sufficiently even if you activate the Flicker-Reduction function. In such cases, use the electronic shutter.

## Time Data

### Setting the Timecode

Specify the timecode to be recorded with “Timecode” and “TC Format” in the TC/UB SET menu (*page 92*).

### Setting the Users Bit

You can add a hexadecimal number of 8 digits for pictures as the user bits.

The user bits can also be set to the current date. Use “Users Bit” (*page 92*) in the TC/UB SET menu.

### Displaying the Time Data

Pressing the DISPLAY button displays the time data on the screen (*page 19*).

The indication is switched among the timecode, user bits, and recording duration each time you press the DURATION/TC/U-BIT button (*page 15*).

Display	Contents
TCG **:**:**:**:**	Timecode
CLK **:**:**:**:**	Timecode (Clock mode)
UBG ** ** ** **	User bits
DUR **:**:**:**	Duration from the beginning of recording

## Recording Audio Signals

Four channels (CH-1/CH-2/CH-3/CH-4) of audio can be recorded (Linear PCM recording) in synchronization with video recording. You can use the built-in stereo microphones (omni-directional electret condenser microphones) or 2-channel external audio inputs to the AUDIO IN connectors by switching with the AUDIO IN switches.

### Using the Built-in Stereo Microphones

Set the AUDIO IN switches, both CH-1 and CH-2 (page 16), to INT.

### Using External Inputs

- 1 Set the AUDIO IN switches CH-1 and CH-2 to EXT.
- 2 Connect external audio sources to the AUDIO IN connectors CH-1 and CH-2 (page 14).
- 3 Set the input (LINE/MIC/MIC+48V) switches CH-1 and CH-2 (page 14) to LINE (line level: +4 dBu).

### Using an External Microphone

You can use an external microphone for recording, such as the ECM-673 Electret Condenser Microphone.

- 1 Lift up the handle of the external microphone holder (page 14) and open the cover.
- 2 Attach a microphone, then return the external microphone holder cover to its original position to secure it.

- 3 Connect the microphone cable to the AUDIO IN CH-1/CH-2 connectors.

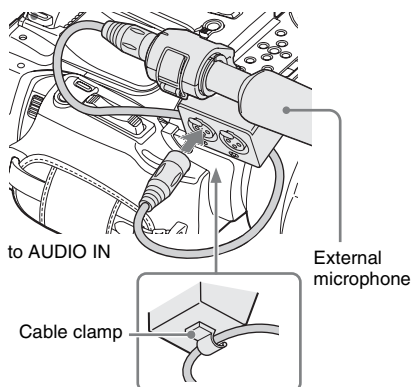

- 4 Set the corresponding AUDIO IN switch (CH-1/CH-2) (page 16) to EXT.

- 5 Set the corresponding input (LINE/MIC/MIC+48V) switch (CH-1/CH-2) (page 14) according to the connected microphone.

**MIC:** For a microphone that requires no power supply

**MIC +48V:** For a microphone that requires +48V power supply (such as the ECM-673)

### Adjusting the Audio Recording Levels

#### To adjust the levels automatically (AGC)

When the AUDIO SELECT switches CH-1 and CH-2 (page 16) are set to AUTO, the audio recording levels are automatically adjusted.

---

## To adjust the levels manually

---

Set the AUDIO SELECT switches CH-1 and CH-2 to MANUAL and adjust the audio recording levels by turning the AUDIO LEVEL knobs (*page 16*).

Set the controls to 5 for the reference setting (0 dB). Setting to 10 maximizes the level (+12 dB), and setting to 0 minimizes it ( $-\infty$ ).

The input levels are displayed on the screen when you press the DISPLAY button (*page 19*).

---

## Audio recording in special recording modes

---

No audio recording is made in Interval Recording or Frame Recording.

No audio recording is made in Slow & Quick recording if the recording frame rate is set to a value different from the playback frame rate.

## Monitoring the Audio

You can monitor the sounds being recorded with the headphones connected to the headphone connector (stereo mini jack) (*page 13*).

### Note

The built-in speaker is disabled during recording (or when standing by to record).

### To adjust the audio monitoring volume

Use the VOLUME buttons (*page 15*).

# Useful Functions

## Color Bars/Reference Tone

By setting “Camera/Bars” in “Color Bars” (*page 81*) in the CAMERA SET menu to “Bars,” you can output a color-bar signal in place of the camera picture. When this item is set to “Camera,” the output returns to the camera picture.

A 1-kHz reference tone is output with the color bar signal if “1KHz Tone” in “Audio Input” (*page 86*) in the AUDIO SET menu is set to “On.”

The color-bar signal and reference-tone signal are also fed out from the SDI OUT, HDMI OUT, i.LINK, VIDEO OUT (color bars only), and A/V OUT connectors.

You can select the type of color bars with “Bars Type” in “Color Bars” in the CAMERA SET menu.

### Notes

- The color bar mode cannot be output in Slow & Quick Motion mode and SLS/EX SLS mode.
- You cannot switch to “Color Bars” while recording. (Switching from “Color Bars” to “Camera” is available.)

## Shot Marks

When you record shot marks for important scenes of a clip recorded in UDF or FAT HD as subsidiary data, you can access the marked points easily on a Shot Mark screen (*page 72*), which only displays scenes with shot marks only. This increases editing efficiency.

The camcorder permits you to record two types of shot marks: shot mark 1 and shot mark 2.

Shot marks can be recorded as needed during recording or can be added after recording while checking the playback pictures on the thumbnail screen.

---

## Inserting a shot mark during recording

---

Activate the IR Remote Commander (*page 24*), and press the SHOTMARK 1 or SHOTMARK 2 button where you want to insert a shot mark. If the Shot Mark 1 or Shot Mark 2 function is assigned to

an assignable button (page 48), you can also use that button.

*For operations to add shot marks after recording, see “Adding Shot Marks During Playback (UDF and FAT HD Mode)” on page 66 and “Adding/Deleting Shot Marks (UDF and FAT HD Mode)” on page 72.*

*For operation to apply a name to a shot mark, see “Defining Shot Mark names in Planning Metadata” on page 62.*

## OK/NG/KP Flags (for UDF Only)

You can add OK/NG/KP flags to clips recorded with UDF. By adding flags, you can set the camcorder to display only clips with certain flag settings on the thumbnail screen (OK/NG/KP/None-Clip thumbnail screen) (page 64).

### Note

Use the “Lock Clip” setting (page 67) to protect clips.

## Adding a flag

**During recording or playback, press the assignable button to which you assigned the Clip Flag OK/Clip Flag NG/Clip Flag Keep function.**

You can add an OK/NG/KP flag to a clip during recording or playback.

## Deleting a flag

**Press the assignable button, twice in succession, to which you assigned the Clip Flag OK/Clip Flag NG/Clip Flag Keep function.**

You can delete the OK/NG/KP flag from a clip. *OK/NG/KP flags can also be added and deleted from the thumbnail screen. For details, see “Adding/Deleting a Flag (UDF Only)” (page 69).*

## OK Mark (for FAT HD Mode Only)

By adding the OK mark to a clip recorded in FAT HD Mode, you can prevent the clip from being deleted or divided inadvertently. You can also set the camcorder to display only clips with the OK mark on the thumbnail screen (OK-Clip thumbnail screen) (page 64).

## Adding the OK mark

**When recording of a clip ends, press the assignable button to which you assigned the OK Mark function.**

While standing by to record, you can also add an OK mark to the last-recorded clip (“Last Clip”) on the selected memory card.

## Deleting the OK mark

**Press the assignable button to which you assigned the OK Mark function, and select “Execute.”**

While standing by to record, you can also delete the OK mark from the clip with the last-added OK mark.

## Adding or deleting the OK mark to or from clips before the last one

Make changes via the thumbnail screen.

*For details on making settings, see “Adding/Deleting the OK Mark (FAT HD Mode Only)” (page 69).*

## Rec Review

You can review the last recorded clip on the screen (Rec Review).

**Press the REC REVIEW button (page 17) after recording is finished.**

If the Rec Review function is assigned to an assignable button (page 48), you can also use that button.

The last 3 seconds, 10 seconds, or the entire part of the clip is displayed, depending on the “Rec Review” setting (page 83) in the CAMERA SET menu.

Rec Review is terminated at the end of the clip, resuming STBY (recording standby) status.

### To interrupt Rec Review

Press the REC REVIEW or STOP/CAM button or the assignable button to which you assigned the Rec Review function.

### Notes

- During Rec Review playback, the playback control buttons other than the STOP/CAM button are disabled.
- If the video format was changed after recording, Rec Review cannot be performed (except when the change was from SP 1440/23.998P to SP 1440/59.94i).

- The Setup and PICTURE PROFILE menus cannot be operated during Rec Review.

## Assignable Buttons

The camcorder has assignable buttons (five for PMW-200, four for PMW-100) (page 16) to which you can assign various functions for convenience.

### To change functions

Use “Assign Button” (page 95) in the OTHERS menu.

The assigned functions can be viewed on the Button/Remote status screen (page 75).

## Interval Recording

The Interval Recording (time-lapse recording) function is especially effective for shooting objects that move very slowly.

The specified number of frames are automatically recorded at the specified intervals.

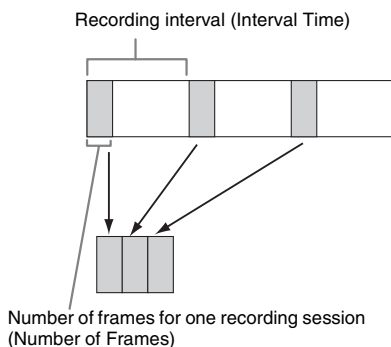

It is recommended to fix the camcorder to a tripod or equivalent and use the IR Remote Commander to start/stop recording rather than pressing the REC START/STOP button of the camcorder.

### Notes

- Audio cannot be recorded in Interval Recording mode.
- Interval Recording cannot be set to “On” simultaneously with Frame Recording, Picture Cache Recording, Slow & Quick Motion, or Clip Continuous Recording. When you set Interval Recording to “On,” these other functions are forcibly set to “Off.”
- Interval Recording mode cannot be used when “Format” in “System” (page 97) in the OTHERS menu is set to “HD420 HQ/720/23.98P” (in UDF HD Mode) or “SP 1440/23.98P” (in FAT HD Mode).

- Interval Recording mode cannot be used when the items “DVCAM” or “HDV” are set for “SDI/HDMI/i.LINK I/O Select” (page 88) in the VIDEO SET menu, and the video format of “Format” in “System” (page 97) in the OTHERS menu is set to other than “HQ mode/23.98P.”

## Preparatory settings

Before starting Interval Recording, make the necessary settings in the CAMERA SET menu (page 83) in advance.

## Performing Interval Recording

When the preparatory settings are completed, you can start recording.

### Press the REC START/STOP button.

#### Notes

- You cannot change the “Interval Time” and “Number of Frames” settings while Interval Recording is in progress. To change them, pause recording.
- After starting Interval Recording, Rec Review operation is disabled, even during an interval.
- The timecode is recorded in Rec Run mode (page 92) during Interval Recording.
- Some extra frames may be recorded if you stop recording or switch the card slot while recording is halted in Interval Recording mode.
- “Setting” for “Interval Rec” is automatically set to “Off” when you set the power switch to OFF, while the “Interval Time” and “Number of Frames” settings are maintained.

## Frame Recording

The Frame Recording function is especially effective for clay animation recording.

The specified number of frames are recorded intermittently when you press the REC START/STOP button.

It is recommended to fix the camcorder to a tripod or equivalent and use the IR Remote Commander to start/stop recording rather than pressing the REC START/STOP button of the camcorder.

#### Notes

- Audio cannot be recorded in Frame Recording mode.
- Frame Recording cannot be set to “On” simultaneously with Interval Recording, Picture Cache Recording, Slow & Quick Motion, or Clip Continuous Recording. When you set Frame Recording to “On,” these other functions are forcibly set to “Off.”
- Frame Recording mode cannot be used when “Format” in “System” (page 97) in the OTHERS menu is set to “HD420 HQ/720/23.98P” (in UDF HD Mode) or “SP 1440/23.98P” (in FAT HD Mode).



- Frame Recording mode cannot be used when the items “DVCAM” or “HDV” are set for “SDI/HDMI/i.LINK I/O Select” (page 88) in the VIDEO SET menu, and the video format of “Format” in “System” (page 97) in the OTHERS menu is set to other than “HQ mode/ 23.98P.”

## Preparatory settings

Before starting Frame Recording, make the necessary settings in the CAMERA SET menu (page 83) in advance.

## Performing Frame Recording

When the preparatory settings are completed, you can start recording.

### 1 Press the REC START/STOP button.

When the number of frames you specified with the menu are recorded, the camcorder automatically enters FRM STBY (Frame Rec Standby) status.

### 2 Press the REC START/STOP button again.

Each time you press the REC START/STOP button, the camcorder records the specified number of frames then enters FRM STBY status.

#### Notes

- Recording cannot be stopped until the specified number of frames are recorded. If the power switch is set to OFF during recording, the power is only shut off after the specified number of frames are recorded.
- The Rec Review function cannot be used while recording in Frame Rec mode is in progress.
- You cannot change the “Number of Frames” setting while recording in Frame Rec mode is in progress. To change it, pause the recording.
- The timecode is recorded in Rec Run mode (page 92) during Frame Recording.
- Some extra frames may be recorded if you stop recording or switch the card slot while recording is paused in Frame Rec mode.
- “Setting” for “Frame Rec” is automatically set to “Off” when you set the power switch to OFF, while the “Number of Frames” setting is maintained.

## Clip Continuous Recording (UDF Only)

Clips are normally created individually for each time you start and stop recording, but you can also continue recording to a single clip regardless of the number of times you start and stop recording

by using the Clip Continuous Recording function, which will add recordings to the same clip until the function is disabled or turned off.

This is convenient for when you do not want to create a large number of short clips, or when you do not want to be restricted by a maximum number of clips.

A recording start mark is added to each point at which you resume recording, making it easy to search for each point.

## Preparatory settings

Before starting Clip Continuous Recording, make the necessary settings to “Clip Cont. Rec” (page 83) in the CAMERA SET menu in advance.

When you set “Setting” to “On,” the Clip Continuous Recording function is enabled, and “CONT” appears on the screen (page 19).

You can also assign “Clip Cont. Rec” to an assignable button (page 48), and set “Setting” to “On”/“Off” by pressing the button.

#### Notes

- Clip Continuous Recording cannot be set to “On” simultaneously with Picture Cache Recording, Interval Recording, Frame Recording, or Slow & Quick Motion. When you set Clip Continuous Recording to “On,” these other functions are forcibly set to “Off.”
- Clip Continuous Recording cannot be used while recording.
- This function cannot be used with FAT.

## Performing Clip Continuous Recording

When the preparatory settings are completed, you can start recording.

### Press the REC START/STOP button.

When recording starts, the “CONT” indication on the screen changes to “●REC” (with ● in red).

#### Notes

- If you remove the SxS memory card or the battery while recording or standing by to record (the “CONT” indication appears), the SxS memory card must be restored. Only remove the SxS memory card after Clip Continuous Recording is complete. If “CONT” is flashing (1 time per second), you can remove the SxS memory card.
- Record for at least 2 seconds before you stop recording.

### To disable Clip Continuous Recording mode

While standing by to record, set “Setting” in “Clip Cont. Rec” (page 83) in the CAMERA SET menu to “Off.”

## Restricted Operations

If you perform any of the following operations while recording or standing by to record, 1 continuous clip will not be created. The next time you start recording, a new clip will be created.

- Performing clip operations (locking, deleting, or changing the names of clips).
- Switching the memory card slot.
- Changing the recording format.
- Setting the power switch to OFF.
- Displaying the thumbnail screen.
- Playing clips.

## Picture Cache Recording: Retroactively Record

When the Picture Cache Recording function is active, the camcorder stores the last few seconds of video captured in the built-in cache memory to permit you to start recording video on an SxS memory card from a point before you press the REC START/STOP button. The maximum picture cache time is 15 seconds.

### Notes

- Picture Cache Recording cannot be set to “On” simultaneously with Frame Recording, Interval Recording, Slow & Quick Motion, or Clip Continuous Recording. When you set Picture Cache Recording to “On,” these functions are forcefully disabled.
- Picture Cache Recording mode cannot be used while recording, or while using Recording Review or Freeze Mix.
- Picture Cache Recording is set to “Off” when you change any of the settings in “System” (page 97) in the OTHERS menu.
- When Picture Cache Recording is “On,” the time code is always recorded in Free Run mode regardless of the TC/UB SET menu settings (page 92).

## Preparatory settings

Before starting Picture Cache Recording, set “P.Cache Rec” (page 83) in the CAMERA SET menu.

“Setting” for Picture Cache Recording can also be set to “On”/“Off” by assigning it to an assignable button (page 48) and using that button.

When the setting has been made, the special recording/operation status indication block on the screen shows “●CACHE,” with ● in green (page 19).

## Performing Picture Cache Recording

### Press the REC START/STOP button.

Recording begins, and stored video in the cache memory is written first to the SxS memory card. The on-screen “●CACHE” indication changes to “●REC” (● is red).

### To cancel the Picture Cache Recording function

Set “Setting” in “P.Cache Rec” in the CAMERA SET menu to “Off” or press the assignable button to which you assigned the Picture Cache function.

### Notes

- If you change the recording format, the cached data are cleared and caching is newly started. Therefore, data cached before you changed the format cannot be recorded if you start Picture Cache Recording immediately after changing the format.
- If you start/stop Picture Cache Recording immediately after you insert an SxS memory card, data may not be recorded on the card.
- Picture caching starts when you activate the Picture Cache Recording function. Therefore, video before the function is activated cannot be recorded with Picture Cache Recording.
- Picture Cache Recording is invalid for external input signal (HDV).
- As picture caching is disabled while an SxS memory card is being accessed, such as during playback, Rec Review, or thumbnail screen display, Picture Cache Recording of such a period cannot be made.
- Although you can change the cache time setting while recording, any new value becomes valid only after recording has stopped.

## Slow & Quick Motion

When the camcorder is in UDF HD Mode or FAT HD Mode and the video format (page 97) is set to one of the following settings, you can set the recording frame rate and playback frame rate to different values.

### NTSC Area

HD422 50/1080/29.97P, HD422 50/1080/23.98P, HD422 50/720/59.94P, HD420 HQ/720/59.94P, HD422 50/720/29.97P, HD422 50/720/23.98P HQ 1920/29.97P, HQ 1920/23.98P, HQ 1280/59.94P, HQ 1280/29.97P, HQ 1280/23.98P

### PAL Area

HD422 50/1080/25P, HD422 50/720/50P, HD420 HQ/720/50P, HD422 50/720/25P HQ 1920/25P, HQ 1280/50P, HQ 1280/25P

**Notes**

- Slow & Quick Motion recording cannot be used in SD Mode.
- Slow & Quick Motion cannot be set to “On” simultaneously with Frame Recording, Interval Recording, Picture Cache Recording, or Clip Continuous Recording. When you set Slow & Quick Motion to “On,” these other functions are forcibly set to “Off.”
- Slow & Quick Motion mode cannot be used while recording, or while using Recording Review or Freeze Mix.
- Slow & Quick Motion mode cannot be used when “SLS/EX SLS” (page 81) in the CAMERA SET menu is set to other than OFF.
- Audio cannot be recorded when the recording and playback frame rates differ.

**Preparatory settings**

Before starting Slow & Quick Motion recording, set “S&Q Motion” (page 83) in the CAMERA SET menu.

When the special recording mode indication on the screen is active, “S&Q Motion” is displayed on the screen (page 19).

**Setting the recording frame rate with the Direct menu**

When the special recording mode indication on the screen is active, [Recording frame rate]/[Playback frame rate fps] is displayed under “S&Q Motion.”

You can change the recording frame rate with the Direct menu (page 20).

**Recording in Slow & Quick Motion Mode**

When the preparatory settings are completed, you can start recording.

**Press the REC START/STOP button.****Notes**

- You cannot change the Frame Rate settings while Slow & Quick Motion recording is in progress. To change them, pause the recording.
- The timecode is recorded in Rec Run mode during Slow & Quick Motion recording (page 92).
- When recording at a low-speed frame rate, it may take time until recording stops after you press the REC START/STOP button.
- Slow & Quick Motion mode is automatically set to “Off” when you set the camcorder’s power switch to OFF. However, the Frame Rate setting is saved.

**Freeze Mix: Image Alignment**

In UDF HD Mode or FAT HD Mode, an image (still picture) of a recorded clip can be temporarily superimposed on the current camera picture, permitting you to easily align images for your next recording.

**To use the Freeze Mix function**

While standing by to record, assign the Freeze Mix function to one of the assignable buttons (page 48).

**Superimposing a Freeze Mix image**

While recording or reviewing images by pressing the REC REVIEW button, press the ASSIGN button to which you assigned “Freeze Mix” at the image with which you want to align. The image is displayed as a still picture over the current camera picture.

**Canceling Freeze Mix status**

You can cancel it with the ASSIGN button to which you assigned “Freeze Mix” or the REC START/STOP button.

When you cancel Freeze Mix status by pressing the ASSIGN button, the normal camera picture is displayed.

When you cancel Freeze Mix status by pressing the REC START/STOP button, normal recording begins.

**Notes**

- The Freeze Mix function cannot be used in SD Mode.
- Freeze Mix cannot be used when “Format” in “System” (page 97) in the OTHERS menu is set to “HD420 HQ/720/23.98P” (in UDF HD Mode) or “SP 1440/23.98P” (in FAT HD Mode).
- If the “Format” setting of the recorded picture and the current camera picture differ, the Freeze Mix display cannot be achieved.
- The Freeze Mix display cannot be obtained in Slow & Quick Motion mode or Slow Shutter mode.
- You cannot operate the Setup menus and PICTURE PROFILE menu in Freeze Mix status.

## Picture Profiles

You can customize the picture quality, depending on the conditions or circumstances of recording, and store settings as a picture profile, enabling you to recall the profile as necessary.

Six different picture profiles (PP1 to PP6) can be stored in memory.

The same standard (reference) values are registered to six picture profiles at the factory as those specified for the Picture Profile Off status.

### Note

The picture profiles can be operated only while standing by to record. They cannot be operated from the thumbnail screen.

---

### Registering the customized settings as a Picture Profile

---

- 1 Set the power switch (page 13) to ON to turn on the camcorder.**
- 2 Press the PICTURE PROFILE button (page 16).**  
The PICTURE PROFILE menu is displayed.
- 3 Using the up/down/left/right buttons or the jog dial, select “SEL,” then press the SEL/SET button or the jog dial.**
- 4 Select the number of the picture profile to register from the list, then press the SEL/SET button or the jog dial.**
- 5 Use the up/down buttons or the jog dial to select “SET,” then press the SEL/SET button or the jog dial.**
- 6 Make each setting (page 53).**
- 7 When the settings have been made, press the PICTURE PROFILE button.**

---

### Selecting a registered Picture Profile

---

Once you store a picture profile, you can recall the picture quality registered in the picture profile.

- 1 While standing by to record, press the PICTURE PROFILE button (page 16).**  
The PICTURE PROFILE menu is displayed.

- 2 Using the up/down/left/right buttons or the jog dial, select “SEL,” then press the SEL/SET button or the jog dial.**

- 3 Select the number of the picture profile to use from the list, then press the SEL/SET button or the jog dial.**

If OFF is selected, the picture quality is set to standard and cannot be changed.

- 4 Press the PICTURE PROFILE button.**

The picture profile being selected is displayed when you press the DISPLAY button (page 19). You can also select picture profiles with the Direct menu (page 20).

## Picture Profile Items

The values when “Off” is selected at “SEL” of the PICTURE PROFILE menu are shown in bold face (example: **Standard**).

PICTURE PROFILE SET		
Items	Subitems and setting values	Contents
<b>Profile Name</b>	Profile name	Set the profile name in 8 characters at maximum.
Changing the picture profile name	<b>Standard</b>	You can use upper- and lowercase alphabets, numerics 0 to 9, - (hyphen), _ (underscore) and space.
<b>Matrix</b>	Setting	Set to “On” to activate the color phase adjustment function with matrix operations for the entire picture.
Adjusting the color phase over the entire area with matrix operations	<b>On / Off</b>	<p><b>Note</b></p> <p>When this function is set to “Off,” Multi Matrix is also set to “Off” in synchronization.</p>
	Select	Select the built-in preset matrix provided for convenience.
	1 / <b>2</b> / 3 / 4 / 5 / 6	1: Equivalent to SMPTE-240M / 2: Equivalent to ITU-709 / 3: Equivalent to SMPTE WIDE / 4: Equivalent to NTSC / 5: Equivalent to EBU / 6: Equivalent to PAL
	Level	Adjust the color saturation for the entire picture area.
	-99 to +99 ( <b>±0</b> )	
	Phase	Adjust the hue for the entire picture area.
	-99 to +99 ( <b>±0</b> )	
	R-G, R-B, G-R, G-B, B-R, B-G	Finely adjust the color phase for the entire picture area by independently setting each of the factors.
	-99 to +99 ( <b>±0</b> )	
<b>Multi Matrix mode (PMW-200 only)</b>	Multi Matrix / <b>Color Correction</b>	Select the setting items of the Multi Matrix or the setting items of the Color Correction.
Selecting multi-matrix correction and color phase adjustment for the specified area		
<b>Multi Matrix</b>	Setting	Set to “On” to enable the multi-matrix correction, which allows specific colors to be selected for saturation correction in a 16-axis hue space.
Makes settings related to multi-matrix correction.	<b>On / Off</b>	
(Unselectable when “Color Correction” is selected in the Multi Matrix mode: PMW-200 only)	Area Indication <sup>1)</sup>	Set to “On” to display a zebra pattern in the areas of the specified color for multi-matrix correction.
	<b>On / Off</b>	
	Color Detection <sup>2)</sup>	Execute to detect the target color on the screen for multi-matrix correction.
	Execute/Cancel	
	Axis	Specify a color targeted by multi-matrix correction (16-axis mode).
	<b>B</b> / B+ / MG- / MG / MG+ / R / R+ / YL- / YL / YL+ / G- / G / G+ / CY / CY+ / B-	
	Hue	Set the the hue of the color targeted by multi-matrix correction for each 16-axis mode.
	-99 to +99 ( <b>±0</b> )	
	Saturation	Adjust the saturation of the color targeted by multi-matrix correction for each 16-axis mode.
	-99 to +99 ( <b>±0</b> )	

PICTURE PROFILE SET		
Items	Subitems and setting values	Contents
<b>Color Correction (PMW-200 only)</b> Adjusting the color phase in a specific area (Unselectable when “Multi Matrix” is selected in the Multi Matrix mode)	Setting On / <b>Off</b>	Set to “On” to enable the color phase adjustment for a specific area. (Simultaneous adjustment of multiple areas is not allowed. You can adjust it for one area only.)
	Area Detection <sup>2)</sup> Execute/Cancel	Execute to detect the color in the center of the screen. The area centering around the detected color of the range specified by “Target Width” becomes the target area of Color Correction.
	Area Indication <sup>1)</sup> On / <b>Off</b>	Set to “On” to display the Zebra 1 pattern for the area targeted for Color Correction.
		<b>Note</b> The area where the Zebra 1 pattern is displayed and the area targeted for Color Correction, may differ.
	Target Phase 0 to 359 ( <b>130</b> )	Manually adjust the center color for the area targeted for Color Correction.
		<b>Note</b> When Area Detection is executed, this setting is overwritten by the Area Detection result. Perform fine adjustment with this item as required.
	Target Width 0 to 90 ( <b>40</b> )	Set the width of color phase for the area targeted for Color Correction.
Level -99 to +99 ( <b>±0</b> )	Set the saturation for the color in the target area.	
Phase -99 to +99 ( <b>±0</b> )	Adjust the hue for the color in the target area.	
<b>White</b> Setting the white balance offset and the color temperature of the preset white	Offset White On / <b>Off</b>	Set to “On” to shift the conversion value for auto white balance in Memory A or B mode and that for auto tracing white in ATW mode to a lower color temperature or a higher color temperature.
	Offset<A> -99 to +99 ( <b>±0</b> )	Adjust the volume of the offset white (shifting volumes) of the conversion value in Memory A, Memory B, or ATW mode, respectively.
	Offset<B> -99 to +99 ( <b>±0</b> )	
	Offset<ATW> -99 to +99 ( <b>±0</b> )	
	Preset White 2100 to 10000 ( <b>3200</b> )	Adjust the preset color temperature when Preset white balance mode is selected in steps of 100K.
	<b>Notes</b>	<ul style="list-style-type: none"> <li>• Except when the white balance is in Memory A or B mode or when ATW is active, you cannot confirm the result of changing the Offset White and Offset settings on the screen.</li> <li>• Except when Preset white balance mode is selected, you cannot confirm the result of changing the Preset White settings on the screen.</li> </ul>

**PICTURE PROFILE SET**

<b>Items</b>	<b>Subitems and setting values</b>	<b>Contents</b>
<b>HD Detail</b> Adjusting the details to be applied to the picture in HD Mode	Setting <b>On / Off</b>	Set to "On" to apply the details to the video signal.
	Level -99 to +99 ( <b>±0</b> )	Adjust the detail level.
	Frequency -99 to +99 ( <b>±0</b> )	Set the center frequency of the details. Setting the center frequency higher decreases the details, and setting it lower increases the details.
	Crispening -99 to +99 ( <b>±0</b> )	Adjust the noise-suppression level. When you set it to a higher level, less noise may be seen, as fine elements of details are deleted leaving only high-level elements. When you set it to a lower level, fine elements are applied while increasing noise.
	H/V Ratio -99 to +99 ( <b>±0</b> )	Adjust the horizontal-to-vertical ratio of detail elements. A higher value makes the vertical elements increased with respect to the horizontal elements.
	White Limiter -99 to +99 ( <b>±0</b> )	Limit the white details.
	Black Limiter -99 to +99 ( <b>±0</b> )	Limit the black details.
	V DTL Creation NAM / Y / G / <b>G+R</b>	Select the source signal to generate vertical details from among NAM (G or R whichever is higher), Y, G, and G+R.
	Knee APT Level -99 to +99 ( <b>±0</b> )	Adjust the knee aperture level (level of details to be applied to the sections above the knee point).

## PICTURE PROFILE SET

Items	Subitems and setting values	Contents
<b>SD Detail</b> Adjusting the details to be applied to the picture in SD Mode	Setting <b>On / Off</b>	Set to "On" to apply the details to the video signal.
	Level -99 to +99 ( $\pm 0$ )	Adjust the detail level.
	Frequency -99 to +99 ( $\pm 0$ )	Set the center frequency of the details. Setting the center frequency higher decreases the details, and setting it lower increases the details.
	Crispening -99 to +99 ( $\pm 0$ )	Adjust the noise-suppression level. When you set it to a higher level, less noise may be seen, as fine elements of details are deleted leaving only high-level elements. When you set it to a lower level, fine elements are applied while increasing noise.
	H/V Ratio -99 to +99 ( $\pm 0$ )	Adjust the horizontal-to-vertical ratio of detail elements. A higher value makes the vertical elements increased with respect to the horizontal elements.
	White Limiter -99 to +99 ( $\pm 0$ )	Limit the white details.
	Black Limiter -99 to +99 ( $\pm 0$ )	Limit the black details.
	V DTL Creation NAM / Y / G / G+R	Select the source signal to generate vertical details from among NAM (G or R whichever is higher), Y, G, and G+R.
	Knee APT Level -99 to +99 ( $\pm 0$ )	Adjust the knee aperture level (level of details to be applied to the sections above the knee point).
	<b>Skin Tone Detail</b> Adjusting the details to be applied to the areas of a specific color phase	Setting <b>On / Off</b>
Level -99 to +99 ( $\pm 0$ )		Adjust the skin-tone detail level.
Area Detection <sup>2)</sup> Execute/Cancel		Select "Execute" to detect the color in the center of the screen. The area centering on the detected color becomes the target area for Skin Tone Detail control.
Area Indication <sup>1)</sup> <b>On / Off</b>		Set to "On" to display the Zebra 1 pattern for the target area for Skin Tone Detail control.
Saturation -99 to +99 ( $\pm 0$ )		Adjust the color (saturation) level for Skin Tone Detail control.
Phase 0 to 359 ( <b>130</b> )		Adjust the center color-phase value for the target area for Skin Tone Detail control.

**Note**

When Area Detection is executed, this setting is automatically returned to 0.

**Note**

When Area Detection is executed, this setting is automatically changed to the value equivalent to that of the detected color.



**PICTURE PROFILE SET**

Items	Subitems and setting values	Contents	
	Width 0 to 90 ( <b>40</b> )	Adjust the width of the color phase of the target area for Skin Tone Detail control.  <b>Note</b> When Area Detection is executed, the Width setting automatically returns to 40.	
<b>Aperture</b> Making settings related to aperture correction	Setting <b>On / Off</b>	Set to "On" to enable aperture correction (processing to improve resolution by adding high-frequency aperture signals to the video signal, which corrects degeneration due to high-frequency characteristics).	
	Level -99 to +99 ( <b>±0</b> )	Select the level for the aperture correction.	
<b>Knee</b> Adjusting the knee level	Setting <b>On / Off</b>	Set to "On" to compress the high-luminance area of the picture.  <b>Note</b> Knee is fixed and cannot be changed in the following cases: <ul style="list-style-type: none"> <li>• When Gamma is set to HG1 to 4</li> <li>• When the electronic shutter is in slow shutter mode</li> <li>• When EX SLS is active</li> </ul>	
	Auto Knee <b>On / Off</b>	Set to "On" to automatically set the best knee conditions according to the luminance level of the picture. With "Off" the knee conditions can be manually adjusted independently of the luminance level of the picture.	
	Point 50 to 109 ( <b>90</b> )	Set the knee point when Auto Knee is "Off."	
	Slope -99 to +99 ( <b>±0</b> )	Set the knee slope (volume of compression) when Auto Knee is "Off."	
	Knee SAT <b>On / Off</b>	Set to "On" to enable the knee saturation adjustment (level for the area over the knee point).	
	Knee SAT Level -99 to +99 ( <b>±0</b> )	Adjust the knee saturation level for the area over the knee point.	
	<b>White Clip</b>	Setting <b>On / Off</b>	Turns white clipping adjustment on or off.
		Level Except for [PAL Area], the level is selected for Country 90.0%~109.0% ( <b>108.0%</b> ) in [PAL Area], the level is selected for Country 90.0%~109.0% ( <b>105.0%</b> )	Specifies the white clip level.
<b>Gamma</b> Adjusting the gamma compensation level and selecting the gamma curve	Level -99 to +99 ( <b>±0</b> )	Adjust the gamma compensation level.	
	Select <sup>3)</sup> STD1 to STD6 / HG1 to HG4 (HD: <b>STD5</b> , SD: <b>STD4</b> )	Select the type of reference curve for gamma compensation.	

**PICTURE PROFILE SET**

Items	Subitems and setting values	Contents
<b>Black</b> Adjusting the black	-99 to +99 ( $\pm 0$ )	Adjust the master black level.
<b>Black Gamma</b> Adjusting the black gamma level	-99 to +99 (HD: $\pm 0$ , SD: <b>-16</b> )	Adjust the level of black gamma function that emphasizes only the dark areas of the picture to clear the tones or on the contrary de-emphasizes it to reduce noise.
<b>Low Key SAT</b> Adjusting the low key saturation	-99 to +99 ( $\pm 0$ )	Adjust the level of the low key saturation to heighten the colors only in the dark areas of the picture or pale them to reduce noise.
<b>Copy</b> Copying a picture profile	Execute / Cancel	Select "Execute" to copy.
<b>PP Data</b> Writing/loading a picture profile	Store	Select "Execute" to store a picture profile on an SxS memory card.
	Execute / Cancel	
	Recall	Select "Execute" to load a picture profile from an SxS memory card.
	Execute / Cancel	
<b>Reset</b> Resetting a picture profile	Execute / Cancel	Select "Execute" to reset.

1) The Area Indication "On"/"Off" setting is common to all picture profiles PP1 to PP6.

2) To execute "Color Detection" or "Area Detection"

**1. Select "Color Detection" or "Area Detection."**

A square marker that indicates the detection area appears in the center of the screen, and "Execute" and "Cancel" are displayed below.

**2. Select "Execute."**

Color-phase detection in the marker area is performed.

When detection successfully ends, a completion message is displayed then the screen is restored.

With Multi Matrix, the target color of multi-matrix correction is changed to the color detected by "Color Detection," and the Area Indication (zebra pattern) appears on the screen.

With Skin Tone Detail, the target area for the adjustment is changed to the area centering around the color detected by "Area Detection," and the Area Indication (zebra pattern) appears on the screen.

If detection fails, an error message appears, then the previous screen is restored.

3) Available gamma curves from "Select" in "Gamma" (STD: Standard gamma, HD: Hyper gamma)

STD1: A gamma table equivalent to an SD camcorder.

STD2: A gamma table with  $\times 4.5$  gain.

STD3: A gamma table with  $\times 3.5$  gain.

STD4: A gamma table equivalent to the SMPTE-240M standard.

STD5: A gamma table equivalent to the ITU-R709 standard.

STD6: A gamma table with  $\times 5.0$  gain.

HG1: A gamma table for turning 325% D-range input into 100% output.

HG2: A gamma table for turning 460% D-range input into 100% output.

HG3: A gamma table for turning 325% D-range input into 109% output.

HG4: A gamma table for turning 460% D-range input into 109% output.

## Deleting Clips

While standing by to record, the Last Clip DEL function for deleting the last recorded clip and the All Clips DEL function for deleting all clips from an SxS memory card are available.

*For clip deletion on the thumbnail screen, see “Deleting Clips” on page 70.*

### To delete using the assignable button

Assign the Last Clip DEL function to one of the assignable buttons (*page 48*) in advance.

Press the assignable button to which you have assigned “Last Clip DEL,” and select “Execute” to delete the last recorded clip from the SxS memory card.

### To delete using the Setup menu

Select “Last Clip DEL” in “Clip” (*page 98*) in the OTHERS menu, select “Execute,” then select “Execute” again to delete the last recorded clip from the SxS memory card.

#### Note

When Clip Continuous Recording is set to “On,” “Last Clip DEL” cannot be selected.

### Deleting clips collectively

Select “All Clips DEL” in “Clip” (*page 98*) in the OTHERS menu, select “Execute,” then select “Execute” again to delete all the clips from the SxS memory card.

#### Notes

- If the SxS memory card contains clips of both of HD Mode and SD Mode, only the clips of the currently selected mode are deleted.
- Clips with the OK mark (*page 47*) cannot be deleted if FAT is selected for the file system. If UDF is selected, clips set to “Lock Clip” (*page 67*) cannot be deleted.

## Storing/Retrieving the Setting Data

You can store all the menu settings (including picture profiles) as a setup file on an SxS memory card or a USB flash drive (PMW-200 only). By retrieving the stored setup file, the proper setup condition can be immediately obtained.

#### Note

Values for “Clock Set” and “Hours Meter” in the OTHERS menu are not stored.

### Storing the Setup file

#### To use an SxS memory card

Only one setup file—designated with the file name “SETUP.SUF”—can be stored on one SxS memory card.

#### 1 Insert a memory card on which you wish to store the setup file to a card slot.

Check that the corresponding memory card icon is displayed on the screen. If a memory card in the other slot is selected, press the SLOT SELECT button to switch.

#### 2 Select “Store” in “Camera Data” (*page 94*) in the OTHERS menu, then select “EXECUTE.”

An in-progress message is displayed during writing. When writing is completed, a completion message is displayed.

#### Notes

- If a setup file already exists on the memory card you specified in Step 1, a message to confirm whether to overwrite the file is displayed.
- If there is not sufficient space on the memory card, an error message is displayed.

#### To use a USB flash drive (PMW-200 only, in UDF mode)

Connect the formatted USB flash drive to the external device connector (*page 31*). Select All Save(USB) >Execute in step 2.

### Retrieving the Setup file

#### To use an SxS memory card

When you retrieve the stored setup file, the camcorder settings are changed according to the file.

#### 1 Insert the memory card on which you stored the setup file into a card slot.

Check that the corresponding memory card icon is displayed on the screen. If a memory card in the other slot is selected, press the SLOT SELECT button to switch.

## 2 Select “Recall” in “Camera Data” (page 94) in the OTHERS menu, then select “EXECUTE.”

An in-progress message is displayed during data reading. When the read-out is completed, a completion message is displayed, indicating that the camcorder settings have been changed according to the setup file.

### To use a USB flash drive (PMW-200 only, in UDF mode)

Connect the formatted USB flash drive to the external device connector (page 31).  
Select All Save(USB) >Execute in step 2.

## Resetting to the standard values

The current camcorder settings you made through various menu and button operations can be collectively returned to the standard statuses (factory settings) by executing “All Reset” in the OTHERS menu.

## Planning Metadata

Planning metadata is information about shooting and recording plans, recorded in an XML file.

### Example of a planning metadata file

```
<?xml:version="1.0"spencoding="UTF-8"?>
<PlanningMetadata
xmlns=http://xmlns.sony.net/pro/metadata/planningmetadata"
assignId="P0001" creationDate="2011-08-20T17:00:00+09:00"
lastUpdate="2011-09-28T10:30:00+09:00" load="false" version="1.00">
<PropertyssppropertyId="assignment" update="2011-08-20T09:00:00+09:00"
modifiedBy="Chris">
<TitlespusAscii="Typhoon" xml:lang="ja">Typhoon_Strikes_Tokyo</Title>
</Properties>
</PlanningMetadata>
```

You can shoot using clip names and shot mark names defined in advance in a planning metadata file.

This camcorder can display clip names and shot mark names defined in the following languages:

- English
- Chinese
- German
- French
- Italian
- Spanish
- Dutch

- Portuguese
- Swedish
- Norwegian
- Danish
- Finnish

### Notes

- If you define clip and shot mark names in languages other than those listed above, they may not be displayed on the LCD monitor/EVF screen.
- If you define clip and shot mark names in French, Dutch, or Finnish, some characters are displayed in a different but similar font.

## Loading a Planning Metadata file

To record planning metadata together with clips, it is necessary to load a planning metadata file into the camcorder’s memory in advance.

### To use an SxS memory card

Insert the SxS memory card with the planning metadata file (.xml) saved to the directory below into the camcorder’s card slot, then select and load the file via “Load / Slot(A)” or “Load / Slot(B)” in “Plan.Metadata” (page 99) in the OTHERS menu.

UDF: General/Sony/Planning

FAT: BPAV/General/Sony/Planning

### To use a USB flash drive (PMW-200 only, in UDF mode)

## 1 Connect a USB flash drive formatted with the FAT32 file system to the external device connector (page 31).

A file list appears.

### Note

The file list displays up to 64 files. Even if the total number of planning metadata files is 64 or less, all of the planning metadata files may not appear if the directory where they are located on the USB flash drive (General/Sony/Planning) contains 512 or more files.

## 2 Using the up/down/left/right buttons or the jog dial, select the file which you want to load in the file list, then press the SEL/SET button or the jog dial.

### Confirming the detailed information in planning metadata

After loading a planning metadata file into memory of the camcorder, you can check the details of the file, such as the filename, time and

date of file creation, and the titles specified in the file.

Select “Properties” in “Plan.Metadata” (page 99) in the OTHERS menu, then select “Execute.”

### Using the Wi-Fi connection

When connecting the unit with a computer via Wi-Fi, the file transmission can be done accessing the unit’s Web menu from a computer.

## 1 Launch the browser and input http://<camcorder’s IP address> (page 100) in the address bar.

**Example: When the IP address is 192.168.1.10, input http://192.168.1.10 in the address bar.**

## 2 Input the user name and password, then click OK.

User name: admin

Password: (your unit’s model in lowercase; pmw-100 or pmw-200, as appropriate)

### Clearing the loaded planning metadata

To clear the planning data loaded in the camcorder’s memory, proceed as follows: Select “Clear” in “Plan.Metadata” (page 99) in the OTHERS menu, then select “Execute.”

### Defining a clip name in Planning Metadata

The following two types of clip name strings can be written in a planning metadata file.

- ASCII-format name, which is displayed on the EVF screen
- UTF-8-format name, which is actually registered as the clip name

You can select the type for displaying the clip name with “Clip Name Disp” in “Plan.Metadata” (page 99) in the OTHERS menu.

When you specify a clip name in planning metadata, the name is displayed under the operation status indication on the EVF screen.

### Example of clip name strings

Use a text editor to modify the description for the <Title> tag.

The shaded fields in the example are clip name strings. “Typhoon” is described in ASCII format (up to 44 characters).

“Typhoon\_Strikes\_Tokyo” is described in UTF-8 format (up to 44 bytes).

Here, “sp” indicates a space, and ← indicates a carriage return.

```
<?xmlspversion="1.0"spencoding="
UTF-8"?>←
<PlanningMetadataspxmlns="http://
xmlns.sony.net/pro/metadata/
planningmetadata"spassignId="
P0001"spcreationDate="
2011-08-20T17:00:00+09:00"sp
lastUpdate="
2011-09-28T10:30:00+09:00"sp
version="1.00">←
  <PropertiessppropertyId="
assignment"spupdate="
2011-09-28T10:30:00+09:00"sp
modifiedBy="Chris">←
    <TitlespusAscii="Typhoon"sp
xml:lang="en">Typhoon_Strikes_Tokyo
  </Title>←
</Properties>←
</PlanningMetadata>←
```

### Notes

- When you create a file, enter each statement as a single line by breaking a line with a CRLF only after the last character of the line, and do not enter spaces except where specified with “sp.”
- A string of up to 44 bytes (or 44 characters) is valid as a clip name. If a UTF-8-format string exceeds 44 bytes, the string up to the 44th byte is used as the clip name. If only a string in ASCII format is specified, the ASCII-format name up to the 44th characters is used as the clip name. When neither the ASCII-format name string nor UTF-8-format name string is valid, a clip name in the standard format is used.

### Using a clip name defined in planning metadata

Load a planning metadata file that contains the clip name into memory of the camcorder, then select “Plan” in “Auto Naming” in “Clip” (page 98) in the OTHERS menu.

Clip names are generated by adding an underscore ( \_ ) and a 5-digit serial number (00001 to 99999).

**Example:** Typhoon\_Strikes\_Tokyo\_00001,  
Typhoon\_Strikes\_Tokyo\_00002, ...

### Notes

- If the serial number reaches 99999, it returns to 00001 upon the next recording.
- When you load another planning metadata file, the 5-digit serial number returns to 00001.

## Defining Shot Mark names in Planning Metadata

When you record shot mark 1 or shot mark 2, you can apply a name to the shot mark, using a string defined in planning metadata.

### Example of shot mark name strings

Use a text editor to modify the description for the <Meta name> tag.

The shaded fields in the example are shot mark name strings.

Names can be either in ASCII format (up to 32 characters) or UTF-8 format (up to 16 characters). Here, “sp” indicates a space and ↵ indicates a carriage return.

#### Note

If a name string contains even one non-ASCII character, the maximum length of that string is limited to 16 characters.

```
<?xmlspversion="1.0"spencoding="
UTF-8"?>↵
<PlanningMetadata xmlns="http://
xmlns.sony.net/pro/metadata/
planningmetadata"spassignId="
H00123"spcreationDate="
2011-04-15T08:00:00Z"splastUpdate="
2011-04-15T15:00:00Z"spversion="
"1.00">↵
<PropertiessppropertyId=
"assignment"spclass="original"sp
update="2011-04-15T15:00:00Z"sp
modifiedBy="Chris">↵
  <TitlespusAscii="Football
  Game"spxml:lang="en">
  Football Game 15/04/2011
</Title>↵
  <Metaspname="_ShotMark1"sp
  content="Goal"/>↵
  <Metaspname="_ShotMark2"sp
  content="Shoot"/>↵
</Properties>↵
</PlanningMetadata>↵
```

#### Note

When you create a file, enter each statement as a single line by breaking a line with a CRLF only after the last character of the line, and do not enter spaces except where specified with “sp,” except within shot mark name strings.

## Copying Planning Metadata files collectively

You can copy planning metadata files stored in the General folder on an SxS memory card collectively to another SxS memory card. Select “General Files” in “Copy All” (*page 99*) in the OTHERS menu.

# Thumbnail Screens

When you press the THUMBNAIL button (*page 15*), clips recorded on the SxS memory card are displayed as thumbnails on the screen. If no clips are recorded on the card, a no-clip message is displayed. You can start playback from the clip selected on the thumbnail screen. The playback picture can be seen on the LCD monitor/EVF and external monitors.

Press the STOP/CAM button (*page 15*) to exit the thumbnail screen and return to the recording screen.

**Note**

Even if the SxS memory card contains a mixture of HD and SD clips, the normal thumbnail screen shows only clips of the mode selected in "HD/SD" in "System" (*page 97*) in the OTHERS menu.

To display all recorded clips regardless of the HD/SD Mode, switch the screen to the All-Clip thumbnail screen (*page 64*).

## Configuration of the Thumbnail Screen

Data for the clip selected with the cursor are displayed at the bottom of the screen.

The icon of the current SxS memory card is highlighted, shading the nonselected one. (If the card is write-protected, a lock icon is displayed to the left.)

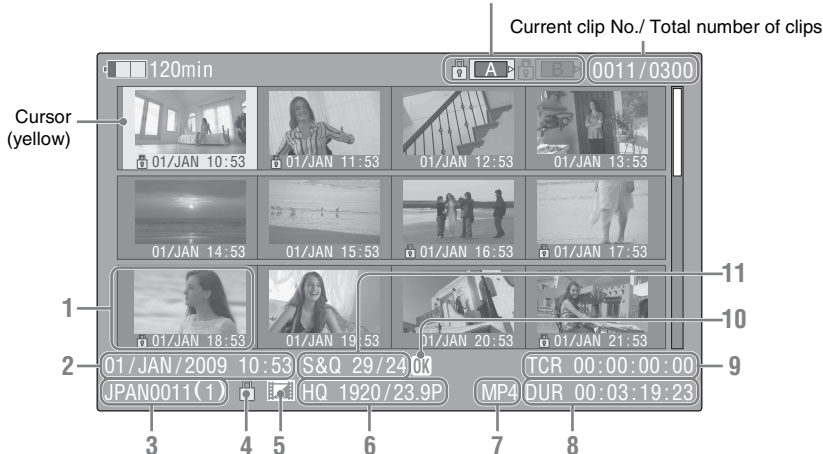

### 1. Thumbnail

In UDF and FAT HD Mode: The thumbnail image for each clip is an index frame from the clip. When recording, the first frame of a clip is automatically set as the index frame. This frame can be adjusted (*page 72*). Below each thumbnail, the recording date and recording start time are displayed. If the clip is locked or is set with an OK mark, the lock mark is displayed.

In FAT SD mode: The thumbnail image for each clip is the first frame of the clip. Below each

thumbnail, the recording date and recording start time are displayed. If the file was split into multiple parts because its file size exceeded 2 GB, the take mark is displayed. Split files can be viewed via the EXPAND CLIP screen (*page 70*).

### 2. Date and starting time of recording

### 3. Clip name

In FAT SD Mode, if the file was split into multiple parts because its file size exceeded 2 GB, the segment number is displayed after the name, separated with a slash.

#### 4. Lock mark (UDF and FAT HD Mode only)

UDF: A lock mark appears if the selected clip is locked.

FAT HD Mode: A lock mark appears if the selected clip has an OK mark.

#### 5. AV independent file icon (UDF and FAT HD Mode only)

Displayed only if the selected clip is an AV independent file. This indicates that not all operations and indications may be available, because the clip may have been added manually to the SxS file via a computer, etc., and there is no management file for it.

#### 6. Recording video format

#### 7. File format

The file format (MXF, MP4, AVI) of the selected clip is displayed. (This item is not indicated when the recording mode is UDF-HD mode.)

#### 8. Duration of the clip

#### 9. Timecode

The timecode of the index frame is displayed.

#### 10. OK/NG/KP mark (UDF and FAT HD Mode only)

UDF: The mark is displayed if the selected clip has an OK/NG/KP flag.

FAT HD Mode: The OK mark is displayed if the selected clip has an OK mark.

#### 11. Special recording information (UDF and FAT HD Mode only)

If the selected clip was recorded in a special recording mode (Slow & Quick Motion, Interval Recording, or Frame Recording), the mode is displayed.

Clips recorded in Slow & Quick Motion display the “Recording frame rate/playback frame rate fps” to the right.

## Changing the Type of Thumbnail Screen

The type of thumbnail screen can be changed as follows by pressing the THUMBNAIL button (*page 15*).

### UDF

The normal thumbnail screen, OK/NG/KP/None clip thumbnail screen, and All-Clip thumbnail screen are cyclically displayed.

### FAT HD Mode

The normal thumbnail screen, OK clip thumbnail screen, and All-Clip thumbnail screen are cyclically displayed.

### FAT SD Mode

The normal thumbnail screen and All-Clip thumbnail screen are alternately displayed.

---

### OK/NG/KP/None-Clip thumbnail screen

---

Only the clips flagged OK/NG/KP—or clips with no flag (“None”)—among the clips on the current SxS memory card are displayed.

You can select the type of flag to display with “Filter Clips” in “Clip” (*page 98*) in the OTHERS menu.

---

### OK-Clip thumbnail screen

---

Only the clips marked OK among the clips on the current SxS memory card are displayed.

---

### All-Clip thumbnail screen

---

The All-Clip thumbnail screen shows all clips on the current SxS memory card regardless of the HD or SD Mode, permitting you to check whether the card contains any clips of another mode than that currently selected.

#### Note

You cannot start playback from the All-Clip thumbnail screen.

Press the THUMBNAIL button again to return to the normal thumbnail screen, and playback and clip operations are enabled.

---

### Switching the SxS memory cards

---

When two memory cards are loaded, press the SLOT SELECT button (*page 16*) to switch memory cards.

#### Note

Card switching is enabled only when the thumbnail screen is displayed or when an external input picture is displayed by pressing the STOP/CAM button.

You cannot switch memory cards during playback. Continuous playback of cards in slots A and B is not possible.



## Playing Clips

For playback operations, use the playback control buttons on the handle (*page 15*). When the IR Remote Commander is enabled, you can use its playback control buttons instead (*page 24*).

### Playing the Selected and Subsequent Clips in Sequence

**1** Using the up/down/left/right buttons or the jog dial, move the cursor to the thumbnail image of the clip with which you wish to start playback.

**2** Press the PLAY/PAUSE button.

Playback starts from the beginning of the selected clip.

#### Notes

- The playback picture may be momentarily distorted or frozen between clips. The playback control buttons and THUMBNAIL button do not function during this condition.
- When you select a clip on the thumbnail screen and start playback, the playback picture at the beginning of the clip may be distorted. To start playback without distortion, once pause playback after starting it, press the PREV button to return to the top of the clip, then restart playback.

### Information displayed on the playback screen

The following information is superimposed on the playback picture.

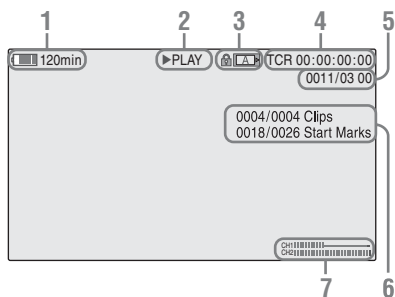

**1. Battery remaining/DC IN voltage**

**2. Playback mode**

**3. SxS memory card**

A  mark appears to the left if the SxS memory card is write-protected.

**4. Time data**

The time data for the playback picture are displayed. Each time you press the DURATION/TC/U-BIT button, the indication is switched between timecode (TCR) and user-bit (UB) data.

**5. Clip no./total number of clips**

This is displayed for FAT. It is also displayed for UDF if “Find Mode” in “Clip” (*page 98*) in the OTHERS menu is set to “Clip.”

**6. Clip no./total number of clips, essence mark no./total number of essence marks**

This is displayed for UDF if “Find Mode” in “Clip” (*page 98*) in the OTHERS menu is set to “Rec Start.”

**7. Audio levels**

The audio levels for the recording are displayed.

## Monitoring Audio

In Normal playback mode, you can monitor the recorded audio signals through the built-in speaker (*page 14*) or connected headphones. With the headphones connected to the headphone connector (*page 13*), the built-in speaker is turned off.

Press the VOLUME buttons (*page 15*) to adjust the sound volume.

You can select audio channel(s) to be monitored with “Audio Output” (*page 87*) in the AUDIO SET menu.

## Cueing Up

### To start playback from the top of the first clip

Press the PREV button and F REV button simultaneously. The top of the first-recorded clip on the memory card is cued up.

### To start playback from the top of the last clip

Press the F FWD button and NEXT button simultaneously. The top of the last-recorded clip on the memory card is cued up.

## Adding Shot Marks During Playback (UDF and FAT HD Mode)

In the same manner as in recording, you can add shot marks to the clip during playback.

**At the point where you wish to add a shot mark, press the “Shot Mark1” or “Shot Mark2” assigned button, or the SHOTMARK 1 or 2 button on the IR Remote Commander.**

### Notes

- No shot mark can be added if the memory card is write-protected.
- No shot mark can be added to the first or last frame of a clip.

## Clip Operations

During thumbnail screen playback, etc., you can operate the clips or confirm and change the subsidiary data for clips using the Clip Operation menus. The corresponding Clip Operation menu pops up on the screens as shown below when you press the SET/SEL button or the jog dial.

## Clip Operation Menus

### Thumbnail screen (*page 67*)

- CANCEL
- DISP CLIP INFO
- OK MARK ADD (FAT only)
- OK MARK DELETE (FAT only)
- OK FLAG ADD (UDF only)
- NG FLAG ADD (UDF only)
- KEEP FLAG ADD (UDF only)
- CLIP FLAG DELETE (UDF only)
- LOCK CLIP (UDF only)
- UNLOCK CLIP (UDF only)
- COPY CLIP
- DELETE CLIP
- ALL MARKS
- SHOT MARK1
- SHOT MARK2
- REC START MARK (UDF only)
- EXPAND CLIP

### Expand Clip screen (page 71)

- CANCEL
- EXPAND (COARSE)
- EXPAND (FINE)
- PAUSE
- SET INDEX PIC
- SHOT MARK1 ADD
- SHOT MARK2 ADD
- SHOT MARK1 DEL
- SHOT MARK2 DEL
- DIVIDE CLIP (FAT only)

### Shot Mark screen (page 72)

- CANCEL
- PAUSE
- SET INDEX PIC
- SHOT MARK1 DEL
- SHOT MARK2 DEL
- DIVIDE CLIP (FAT only)

#### Note

Selectable menu items are limited in SD Mode.

## Basic Operations of the Clip Operation Menus

Use the up/down/left/right buttons or the jog dial to select a menu item, then press the SEL/SET button or the jog dial.

Pressing the CANCEL button restores the previous condition.

Selecting “CANCEL” from a Clip Operation menu turns the Clip Operation menu off.

#### Notes

- When the SxS memory card is write-protected, some operations are unavailable.
- There may be items that cannot be selected depending on the status when the menu is displayed.

## Clip Operation menu on the thumbnail screen

Pressing the SEL/SET button or the jog dial with the thumbnail screen (page 63) displayed calls the Clip Operation menu for the clip at the cursor.

Item	Function
DISP CLIP INFO	Displays the clip's information screen (page 68).
OK MARK ADD <sup>1)</sup>	Adds an OK mark (page 69).
OK MARK DELETE <sup>1)</sup>	Deletes the OK mark (page 69).
OK FLAG ADD <sup>2)</sup>	Adds an OK flag (page 69).
NG FLAG ADD <sup>2)</sup>	Adds a NG flag (page 69).
KEEP FLAG ADD <sup>2)</sup>	Adds a KP flag (page 69).
CLIP FLAG DELETE <sup>2)</sup>	Deletes the flag (page 69).
LOCK CLIP <sup>2)</sup>	Locks and protects a clip (page 69).
UNLOCK CLIP <sup>2)</sup>	Unlocks a protected clip (page 69).
COPY CLIP	Copies the clip to another SxS memory card (page 69).
DELETE CLIP	Deletes the clip (page 70).
ALL MARKS <sup>3)</sup>	Displays thumbnails of all frames with an essence mark recorded (page 71).
SHOT MARK1 <sup>3)</sup>	Displays only thumbnails of frames with shot mark 1 recorded (page 71).
SHOT MARK2 <sup>3)</sup>	Displays only thumbnails of frames with shot mark 2 recorded (page 71).
REC START MARK	Displays thumbnails of frames with a Recording Start mark and the first frames of clips without Recording Start marks (page 71).
EXPAND CLIP	Switches to the EXPAND CLIP screen (page 70).

<sup>1)</sup>Effective with FAT HD Mode only.

<sup>2)</sup>Effective with UDF only.

<sup>3)</sup>Effective with UDF and FAT HD Mode.

## Displaying the Detailed Information of a Clip

Select “DISP CLIP INFO” from a Clip Operation menu.

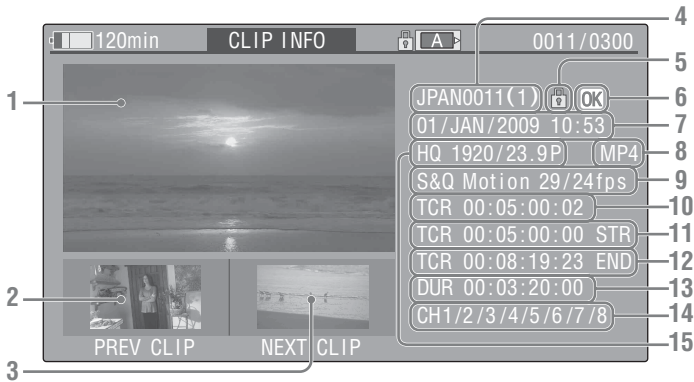

### 1. Image of the current clip

### 2. Image of the previous clip

Press the PREV button to switch to the clip info screen of the previous clip.

In FAT SD Mode, the previous segment of a segmented clip is displayed.

### 3. Image of the next clip

Press the NEXT button to switch to the clip info screen of the next clip.

In FAT SD Mode, the next segment of a segmented clip is displayed.

### 4. Clip name

For a clip name of 12 characters or longer, only the first 5 and last 5 characters of the name are displayed. To check the non-displayed block of the name, press the jog dial or the SEL/SET button to display the entire clip name (Long-Display mode). Press the jog dial or the SEL/SET button again to cancel Long-Display mode. Long-Display mode is also canceled by switching to the previous or next clip with the PREV or NEXT button.

In FAT SD Mode, if the file was split into multiple parts because its file size exceeded 2 GB, the segment number is displayed after the name, separated with a slash.

### 5. Lock mark (UDF and FAT HD Mode only)

UDF: A lock mark appears if the selected clip is locked.

FAT HD Mode: A lock mark appears if the selected clip has an OK mark.

### 6. OK/NG/KP mark (UDF and FAT HD Mode only)

UDF: The mark is displayed if the selected clip has an OK/NG/KP flag.

FAT HD Mode: The OK mark is displayed if the selected clip has an OK mark.

### 7. Date and starting time of recording

### 8. File format

The file format (MXF, MP4, AVI) of the selected clip is displayed.

### 9. Special recording information (UDF and FAT HD Mode only)

If the selected clip was recorded in a special recording mode (Slow & Quick Motion, Interval Recording, or Frame Recording), the mode is displayed.

Clips recorded in Slow & Quick Motion display the “Recording frame rate/playback frame rate fps” to the right.

### 10. Timecode of the displayed frame

### 11. Timecode at the recording starting point

### 12. Timecode at the recording ending point

### 13. Duration of the clip

### 14. Recorded audio channels

### 15. Recorded video format

## Adding/Deleting a Flag (UDF Only)

You can add an OK/NG/KP flag to clips recorded in UDF. By adding flags, you can set the camcorder to display only clips with certain flag settings on the thumbnail screen (OK/NG/KP/None-Clip thumbnail screen) (page 64).

When adding a flag, you can select from OK FLAG ADD, NG FLAG ADD, and KEEP FLAG ADD in the Clip Operation menu (page 67) on the thumbnail screen. When deleting a flag, select CLIP FLAG DELETE.

### Note

Flagged clips are not protected. To protect clips from deletion, select LOCK CLIP in the Clip Operation menu (page 67) on the thumbnail screen. To remove the protection, select UNLOCK CLIP.

## Adding/Deleting the OK Mark (FAT HD Mode Only)

By adding an OK mark to clips recorded in FAT HD Mode, you can set the camcorder to display only the necessary clips on the thumbnail screen (page 64). Clips with an OK mark added are blocked from being deleted or segmented. To delete or segment them, remove the OK mark.

From the thumbnail screen Clip Operation menu (page 67), you can select OK MARK ADD to add an OK mark, or OK MARK DELETE to delete the OK mark.

Select “OK MARK ADD” from the Clip Operation menu to add the OK mark, or select “OK MARK DELETE” from the Clip Operation menu to delete it.

## Copying Clips

You can copy clips on an SxS memory card to another SxS memory card. Each clip is copied with the same name to the destination SxS memory card.

### Notes

- If there is another clip having the same name on the destination SxS memory card, the clip is copied under a name adding a single-digit number in parentheses to the end of the original clip name. The parenthetical number is the minimum value that does not exist in the destination memory card.  
**Examples:**  
ABCD0002(1) if ABCD0002 exists  
ABCD0002(2) if ABCD0002(1) exists  
ABCD0005(4) if ABCD0005(3) exists
- When using FAT, you cannot copy a file 10 times or more if clips with the same clip name followed by parenthetical numbers (1) to (9) already exist on the card.
- When using UDF, you cannot copy a file 1000 times or more if clips with the same clip name followed by parenthetical numbers (1) to (999) already exist on the card.
- A warning message is displayed if there is not sufficient space on the destination SxS memory card. Replace the SxS memory card with one with sufficient space.
- When copying an SxS memory card on which multiple clips have been recorded, copying all clips to the end may not be achieved, even if the destination card has the same capacity as the source card, depending on usage conditions, memory characteristics, etc.

## Copying a specified clip

You can copy a clip selected on the thumbnail screen to another SxS memory card. Select “COPY CLIP” from the Clip Operation menu.

## Copying clips collectively

By using the Setup menu, you can copy clips on an SxS memory card collectively to another SxS memory card.

If the memory card contains clips of both HD and SD Mode, only the clips of the currently selected mode are copied. This may be convenient when you wish to extract clips of the same mode only. Select “Clips” in “Copy All” (page 99) in the OTHERS menu.

## Deleting Clips

You can delete clips from the SxS memory card. Select “DELETE CLIP” from the Clip Operation menu.

### Note

Clips with an OK mark and flagged clips set to LOCK CLIP cannot be deleted. To delete them, release the OK mark or the LOCK CLIP setting before performing the delete operation.

## Deleting clips collectively

By using the Setup menu, you can delete clips from an SxS memory card collectively. Select “All Clips DEL” in “Clip” (page 98) in the OTHERS menu.

### Notes

- If the memory card contains clips of both HD and SD Mode, only the clips of the currently selected mode are deleted.
- Clips with an OK mark and flagged clips set to LOCK CLIP cannot be deleted.

## Displaying the EXPAND CLIP Screen

In UDF and FAT HD Mode, the EXPAND CLIP screen permits you to divide a clip into 12 blocks of equal duration and show a thumbnail image of the first frame of each block on the screen. In FAT SD Mode, the EXPAND CLIP screen shows the thumbnail images of the first frames of the segment files only for a clip segmented because its file size exceeded 2 GB. This helps you to quickly cue up to a desired scene in a clip of long duration. You can display the EXPAND CLIP screen by selecting the clip on the thumbnail screen.

### 1 Select a clip on the thumbnail screen, then press the SEL/SET button or the jog dial.

The corresponding Clip Operation menu pops up.

### 2 Select “EXPAND CLIP.”

The EXPAND CLIP screen appears for the clip that you selected on the thumbnail screen.

## EXPAND CLIP screen in UDF and FAT HD Mode

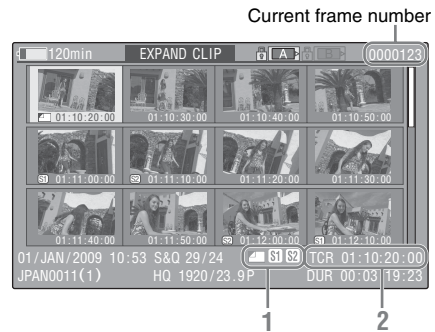

Detailed information for the clip is displayed at the bottom of the screen.

The items other than the following are the same as those on the normal thumbnail screen (page 63):

### 1. Frame information

The following icons show the marking for the frame at the cursor.



Index frame



Frame with shot mark 1 added



Frame with shot mark 2 added

The same icons may also be displayed below the thumbnail image of each frame. If the frame has multiple markings, one of the icons is displayed, in the priority order of index frame, shot mark 1, and shot mark 2.

### 2. Timecode indication

The timecode of the frame at the cursor is displayed.

## EXPAND CLIP screen in FAT SD Mode

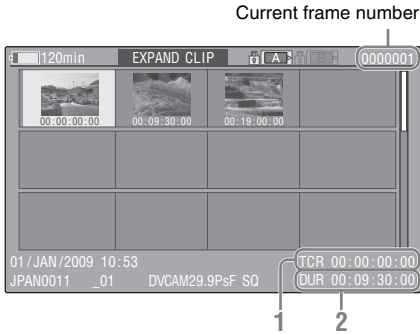

Detailed information for the clip is displayed at the bottom of the screen.

The items other than the following are the same as those on the normal thumbnail screen (*page 63*):

### 1. Timecode indication

The timecode of the segmentation file at the cursor is displayed.

### 2. Duration

The duration of the segmentation file at the cursor is displayed.

## Clip Operation menu on the EXPAND CLIP screen

### UDF and FAT HD Mode

When you select a frame on the EXPAND CLIP screen and press the SEL/SET button or the jog dial, the Clip Operation menu pops up to enable operations such as displaying more detailed split displays and saving the frames after the selected frame as different clip.

Item	Function
EXPAND (COARSE)	To decrease the number of partitions of the clip
EXPAND (FINE)	To increase the number of partitions of the clip
PAUSE	To set to Pause mode at the selected frame
SET INDEX PIC	To specify the selected frame for the index frame of the clip ( <i>page 72</i> )
SHOT MARK1 ADD	To add shot mark 1 to the selected frame ( <i>page 72</i> )
SHOT MARK2 ADD	To add shot mark 2 to the selected frame ( <i>page 72</i> )
SHOT MARK1 DEL	To delete shot mark 1 from the selected frame ( <i>page 72</i> )
SHOT MARK2 DEL	To delete shot mark 2 from the selected frame ( <i>page 72</i> )
DIVIDE CLIP	To divide the clip into two clips at the selected frame ( <i>page 73</i> )

### FAT SD Mode

You can select “PAUSE” only on the EXPAND CLIP screen in FAT SD Mode.

## Displaying the SHOT MARK Screen (UDF and FAT HD Mode)

When one or more shot marks or recording start marks are recorded for a single clip, you can display only frames with those marks as thumbnail images on the screen.

- 1 Select a clip on the thumbnail screen, then press the SEL/SET button or the jog dial.
- 2 Select ALL MARK, SHOT MARK1, SHOT MARK2, or REC START MARK from the Clip Operation menu (*page 67*).

## SHOT MARK screen example (when ALL MARKS is selected)



1

The detailed information of the clip is displayed at the bottom of the screen.

The items other than the following are the same as those on the EXPAND CLIP screen (page 70) in UDF and FAT HD mode:

### 1. Timecode indication

The timecode of the frame at the cursor on the SHOT MARK screen is displayed.

### Move the cursor to the first/last frame

When the cursor is at a user-designated position, press the F REV and PREV buttons simultaneously to move the cursor the first frame. Press the F FWD and NEXT buttons simultaneously to move the cursor to the last frame.

### Switch to the clip shot mark screen for a different clip

When the cursor is at the first frame for a clip, press the PREV or up button, or turn the jog dial up to switch to the previous displayable clip shot mark screen.

When the cursor is at the last frame for a clip, press the NEXT or down button, or turn the jog dial down to switch to the next displayable clip shot mark screen.

### Clip Operation menu on the SHOT MARK screen

When you select a frame on the SHOT MARK screen and press the SEL/SET button or the jog dial, the Clip Operation menu pops up to permit you further operations.

Item	Function
PAUSE	To set to Pause mode at the selected frame
SET INDEX PIC	To specify the selected frame for the index frame of the clip (page 72)
SHOT MARK1 DEL	To delete the shot mark 1 from the selected frame (page 72)
SHOT MARK2 DEL	To delete the shot mark 2 from the selected frame (page 72)
DIVIDE CLIP	To divide the clip into two clips at the selected frame (page 73) (FAT HD mode Only)

## Adding/Deleting Shot Marks (UDF and FAT HD Mode)

### Adding a shot mark in Pause mode

Select “SHOT MARK1 ADD” or “SHOT MARK2 ADD” from the Clip Operation menu.

### Adding a shot mark on the EXPAND CLIP screen

Select “SHOT MARK1 ADD” or “SHOT MARK2 ADD” from the Clip Operation menu.

### Deleting a shot mark

You can delete shot marks on the EXPAND CLIP screen (page 70) or on the SHOT MARK screen (page 71).

Select “SHOT MARK1 DEL” or “SHOT MARK2 DEL” from the Clip Operation menu.

## Changing the Index Frame (UDF and FAT HD Mode)

You can change the index frame to another frame you selected on the EXPAND CLIP screen (page 70) or the SHOT MARK screen (page 71).

Select “SET INDEX PIC” from the Clip Operation menu.

### Note

Even if you specify a frame other than the top frame for the index frame, playback always begins from the top frame when you start it from the thumbnail screen.



## Dividing a Clip (FAT HD Mode Only)

In FAT HD Mode, you can divide a clip into two different clips at the frame you select on the EXPAND CLIP screen (*page 70*) or the SHOT MARK screen (*page 71*).

Select “DIVIDE CLIP” from the Clip Operation menu.

The first 4 characters of the original clip name are carried on, continuing to the last number on the memory card by the second 4 numerics.

**Example:** If you divide a clip named ABCD0002 into two clips under the condition where a new clip will be named EFGH0100, clip ABCD0100 and clip ABCD0101 are created.

### Note

If the remaining space on the memory card is insufficient for divided clips, a message informing you of it appears.

## Showing the Status Screens

Press the STATUS button (*page 15*) to display status screens on the LCD monitor/EVF screen/external video monitor.

Use the up/down buttons (*page 15*) or the jog dial (*page 16*) to perform operations and switch the screens in sequence.

When you press the STATUS button again, the status screen display is canceled.

For connections of an external monitor, see “Connecting External Monitors and Recording Devices” on *page 103*.

### Camera Status Screen

#### White Bal: White balance status

Display	Contents
B	The color temperature stored in white memory B is indicated.
A	The color temperature stored in white memory A is indicated.
PRST	The color temperature set as the preset white is indicated. The color temperature of preset white can be changed using the PICTURE PROFILE menu.

#### Gain: GAIN switch settings

The gain values of the positions L, M, and H of the GAIN switch assigned in the CAMERA SET menu are displayed.

#### Handle Zoom Speed: Handle zoom speed settings

The speed values assigned to each position of the Zoom Speed switch (*page 15*) in “Zoom Speed” (*page 82*) in the CAMERA SET menu are displayed.

Display	Contents
H	Speed obtained when the zoom speed switch is set to the H position
L	Speed obtained when the zoom speed switch is set to the L position

#### Zebra: Zebra status

Display	Contents
1	“On” is displayed and the setting of “Zebra1 Level” in “Zebra” in the LCD/VF SET menu is displayed to the right when “Zebra Select” in “Zebra” in the LCD/VF SET menu is set to “1” or “Both” and you set the Zebra function to “On.” If the Zebra function is set to “Off” or “Zebra Select” is set to “2,” “Off” appears.
2	“On” is displayed when “Zebra Select” in “Zebra” in the LCD/VF SET menu is set to “2” or “Both” and you set the Zebra function to “On.” If the Zebra function is set to “Off” or “Zebra Select” is set to “1,” “Off” appears.

#### Skin Tone Detail: Skin-tone detail status

The current status (On or Off) of “Setting” of “Skin Tone Detail” of the PICTURE PROFILE menu is displayed.

#### Picture Profile: Picture Profile selection status

The selected Picture Profile number and name are displayed. (If Picture Profile is off, “Off” is displayed.)

## Audio Status Screen

### Output CH: External output/headphone output

Depending on the setting of “Output CH” in “Audio Output” in the AUDIO SET menu and the setting of “Monitor CH,” the audio channel(s) external output and headphones output is displayed as follows.

- CH-1: When left/right are CH-1
- CH-2: When left/right are CH-2
- CH-3: When left/right are CH-3
- CH-4: When left/right are CH-4
- CH-1/CH-2: When left is CH-1 and right is CH-2 (stereo)
- CH-3/CH-4: When left is CH-3 and right is CH-4 (stereo)
- CH-1+CH-2: When both left and right are CH-1 and CH-2 (monaural)
- CH-3+CH-4: When both left and right are CH-3 and CH-4 (monaural)

### Speaker: Speaker output

The audio channel(s) output to the internal speaker is displayed.

As the speaker is monaural, CH-1+CH2 or CH-3+CH-4 is displayed when “Monitor CH” is set to stereo. With non-stereo settings, the setting of “Monitor CH” in “Audio Output” in the AUDIO SET menu is displayed as it is.

### CH-1/CH-2/CH-3/CH-4: Audio level meters

The 4-channel audio level meters (2 meters when using 2-channel settings) are displayed.

While recording (or standing by to record), the level of the audio inputs (the EE audio levels) are displayed. During playback, the audio playback level is displayed according to the setting of “Output CH” in “Audio Output” in the AUDIO SET menu.

If audio is input from the i.LINK (HDV/DV) connector while displaying thumbnails, while playback is stopped, or while recording an external signal, the audio input level is displayed. In this case, the leftmost channels that are displayed are CH-1 and CH-2, regardless of the setting of “Output CH” in “Audio Output” in the AUDIO SET menu.

### Wind Filter

The “On”/“Off” setting of Wind Filter is displayed to the right of each input source. Wind Filter settings can be made from “Wind Filter CH1” to “Wind Filter CH4” in “Audio Input” in the AUDIO SET menu.

## Video Status Screen

### Video Format

Video Format: Video format setting  
The number of vertical lines, frame rate, scan format (i/P), and file system (UDF/FAT) of the video format set in “Format” in “System” in the OTHERS menu are displayed.

### Rec Mode: Recording bit rate (HD Mode only)

The recording bit rate of the video format set in “Format” in “System” in the OTHERS menu is displayed.

### SDI Output: Output for SDI

The “SDI” setting in “SDI/HDMI/i.LINK I/O Select” in the VIDEO SET menu is displayed.

### HDMI Output: Output for HDMI

The “HDMI” setting in “SDI/HDMI/i.LINK I/O Select” in the VIDEO SET menu is displayed.

### i.LINK I/O: Input and output for i.LINK

The “i.LINK” setting in “SDI/HDMI/i.LINK I/O Select” in the VIDEO SET menu is displayed.

### Down Converter: SD output down-converter setting

In HD mode, the “Down Converter” setting (Squeeze, Letterbox, Edge Crop) in the VIDEO SET menu is displayed.

In SD mode, “Edge Crop” is displayed when EC (Edge Crop) in “Format” in “System” in the OTHERS menu is selected, and “Squeeze” is displayed when SQ (Squeeze) in “Format” in “System” in the OTHERS menu is selected.

### 23.98P Output: 23.98P output mode

The “23.98P Output” setting (23.98PsF, 59.94i (2-3 Pull Down)) in the VIDEO SET menu is displayed.

## Button/Remote Status Screen

### Assign Button: Assignable button statuses

The functions assigned with the “Assign Button” in the OTHERS menu to the respective assignable buttons are displayed.

### IR Remote: IR Remote Commander status

The “IR Remote” setting in the OTHERS menu is displayed.

## Battery/Media Status Screen

### **Battery: Battery charge remaining**

The remaining charge level of the mounted battery pack is displayed.

### **Charge Count: Repeated charge times**

The number of times that the mounted battery pack has been charged is displayed.

### **HDD A/HDD B: Battery remaining of PHU-220R units**

When professional hard disk units are connected, the remaining power levels of the batteries of the professional hard disk units connected via the respective card slots are displayed.

### **Media A/Media B: Remaining space, available recording time, and estimated service life (rewriting limit)**

The remaining space of the SxS memory cards in the respective card slots is indicated on the meters.

At the right, the available time for recording if done at the current bit rate is displayed, in minutes.

The time indication will be “- - min” if no SxS memory card or an invalid card is in the slot.

If the card is write-protected, a  icon is shown to the right of the time indication.

The Life value is displayed only for an SxS memory card which supports the life value indication. It indicates the estimated remaining usable period of the card (virgin status as 100%). If an alarm is generated, make a backup of the card as soon as possible and replace it with a new card.

# Overview of the Setup Menus

Press the MENU button to display setup menus on the LCD monitor/EVF screen with settings necessary for recording and playback. (You can also display setup menus on an external monitor.) Set items by selecting them from the following menus.

**CAMERA SET menu:** For setting items related to recording other than those for picture quality. (For picture quality-related items, use the PICTURE PROFILE menu (*page 53*.)

**AUDIO SET menu:** For setting audio-related items.

**VIDEO SET menu:** For setting video output-related items.

**LCD/VF SET menu:** For setting items related to the LCD monitor/EVF display.

**TC/UB SET menu:** For setting items related to timecodes and user bits.

**OTHERS menu:** For setting other items.

## Setup Menu Layers

### MENU

- CAMERA SET
  - Gain Setup
  - Shutter
  - SLS/EX SLS (PMW-100 only)
  - EX Slow Shutter (PMW-200 only)
  - MF Assist
  - Color Bars
  - Flicker Reduce
  - Zoom Speed
  - Zoom Transition
  - Interval Rec
  - Frame Rec
  - Clip Cont.Rec
  - P.Cache Rec
  - S&Q Motion
  - Rec Review
  - TLCS
  - Shockless White
  - White Switch<B>
  - ATW Speed
  - Wide Conversion
  - Steady Shot
  - Image Inversion (PMW-200 only)
  - NightShot (PMW-100 only)
  - Exposure (PMW-100 only)
  - Auto Black Bal.
  
- AUDIO SET
  - Audio Input
  - Audio Output
  
- VIDEO SET
  - Input Source Select
  - SDI/HDMI/i.LINK I/O Select
  - SDI/HDMI/Video Out Super
  - Down Converter
  - 23.98P Output
  - SDI Rec Control

(continues)

LCD/VF SET	<ul style="list-style-type: none"> <li>— LCD</li> <li>— EVF</li> <li>— Peaking</li> <li>— Marker</li> <li>— Zebra</li> <li>— Display On/Off</li> </ul>
TC/UB SET	<ul style="list-style-type: none"> <li>— Timecode</li> <li>— Users Bit</li> <li>— TC Format</li> </ul>
OTHERS	<ul style="list-style-type: none"> <li>— All Reset</li> <li>— Camera Data</li> <li>— Time Zone</li> <li>— Clock Set</li> <li>— Language</li> <li>— Assign Button</li> <li>— Tally</li> <li>— Hours Meter</li> <li>— IR Remote</li> <li>— Battery Alarm</li> <li>— Battery INFO</li> <li>— Genlock</li> <li>— Direct Menu</li> <li>— Trigger Mode</li> <li>— System</li> <li>— Clip</li> <li>— Copy All</li> <li>— Format Media</li> <li>— Plan.Metadata</li> <li>— Network (PMW-200 only)</li> <li>— Wi-Fi (PMW-200 only)</li> <li>— Version</li> <li>— Version (Lens) (PMW-100 only)</li> <li>— Version Up</li> <li>— Menu Scroll</li> </ul>

# Basic Menu Operations

## Menu controls

### **MENU button (page 15)**

To turn Menu mode to use Setup menus on/off.

### **Up/Down/Left/Right buttons, SEL/SET button (page 15)**

When you press the up/down/left/right buttons, the cursor moves in the corresponding direction, permitting you to select menu items or setting values.

Press the SEL/SET button to enter the highlighted item.

### **Jog dial (SEL/SET dial) (page 16)**

When you turn the dial, the cursor moves up or down, permitting you to select menu items or setting values.

Press the jog dial to select the highlighted item.

### **CANCEL button (page 15)**

To return to the previous layer of the menu. An uncompleted change is canceled.

#### **Note**

In Expanded Focus mode (page 42), the setup menu cannot be used. Press the EXPANDED FOCUS button to exit this mode.

---

## Setting the Setup menus

---

Rotate the jog dial or press the up/down/left/right buttons to set the cursor to the icon of the menu you wish to set, then push the jog dial or SEL/SET button to select that menu.

- The menu item selection area can show 7 lines at maximum. When all the selectable items cannot be displayed at one time, you can scroll the display up or down by moving the cursor. A triangle appears at the upper or lower right corner of the menu item selection area to indicate that scrolling is enabled.
- For items having a wide range of available values (example: -99 to +99), the available value area is not displayed. The current setting is highlighted instead, indicating that the setting is ready for change.
- When you select “Execute” for an execution item, the corresponding function is executed.
- When you select an item that you must confirm before execution, the menu display temporarily disappears, and a confirmation message is displayed. Following the instructions of the message, and specify whether to execute or cancel.

---

## Entering a character string

---

When you select an item for which a character string, such as a time value or filename, is to be specified, the input area for the character string is highlighted, and “SET” appears at the right end.

- 1 Select characters by pressing the up/down/left/right buttons or turning the jog dial, then press the SEL/SET button or the jog dial to proceed.**

The cursor moves to the next column.  
To return to the previous column, press the left button.
- 2 Perform setting in the same manner up to the last column/digit.**

The cursor moves to “SET.”
- 3 Press the jog dial or the SEL/SET button.**

The setting is completed.

# Setup Menu List

The functions and available settings of menus are listed below.

The default settings set at the factory are shown in bold face (example: **Speed**). The items marked with **M** in the Menu items column cannot be set while displaying the thumbnail screen or during playback operations.

## CAMERA SET Menu

### CAMERA SET

Menu items	Subitems and setting values	Contents
<b>Gain Setup</b> Assigning gain levels to the three GAIN switch positions	Low -3 / <b>0</b> / 3 / 6 / 9 / 12 / 18 dB	Set the gain level to be used when the switch is set to the L position.
	Mid -3 / 0 / 3 / 6 / <b>9</b> / 12 / 18 dB	Set the gain level to be used when the switch is set to the M position.
	High -3 / 0 / 3 / 6 / 9 / 12 / <b>18</b> dB	Set the gain level to be used when the switch is set to the H position.
<b>Shutter</b> Specifying operating conditions of the electrical shutter PMW-200: Unselectable when Supersensitized Slow Shutter mode is set. PMW-100: Unselectable when Slow Shutter mode/ Supersensitized Slow Shutter mode or NightShot mode is set.	Mode <b>Speed</b> / Angle / ECS / SLS (PMW-200 only)	Select modes of the Electronic Shutter. Speed mode/Angle mode (standard modes): These modes may be especially effective when you wish to record a quick-moving subject with minimal blurring. You can select Speed mode to specify the shutter speed in seconds, or Angle mode to specify the shutter speed by the shutter angle. ECS (Extended Clear Scan) mode: This mode may be used to shoot a monitor screen, eliminating horizontal bands. SLS (Slow Shutter mode): The shutter speed is specified in the number of accumulated frames.
	Shutter Speed 1/32, 1/33, 1/40, 1/48, 1/50, 1/60, 1/96, <b>1/100</b> , 1/120, 1/125, 1/250, 1/500, 1/1000, 1/2000	Set the shutter speed when Speed mode is selected. The available setting values vary depending on the frame frequency of the video format selected.
	Shutter Angle 11.25° / 22.5° / 45° / 72° / 86.4° / 90° / 144° / 150° / 172.8° / <b>180°</b> / 216°	Set the shutter angle when Angle mode is selected. The following frame rates are unavailable when "S&Q Motion" is set from "1" to "16": 72°, 86.4°, 144°, 150°, 172.8°, 216°.
	ECS Frequency <b>60.00</b>	Set the ECS frequency when ECS mode is selected. The available setting values vary depending on the frame frequency of the video format selected.
	SLS Frame (PMW-200 only) <b>2</b> to 8 (Off)	Set the number of frames to accumulate when SLS mode is selected. (Off): For S&Q Motion or the SP 24P format (The setting cannot be changed.)



CAMERA SET		
Menu items	Subitems and setting values	Contents
<b>SLS/EX SLS</b> (PMW-100 only) Setting the Slow Shutter mode/ Supersensitized Slow Shutter mode	Setting <b>OFF</b> / 2 / 3 / 4 / 5 / 6 / 7 / 8 / 16 / 32 / 64	Set the number of cached frames.  <b>Notes</b> <ul style="list-style-type: none"> <li>This cannot be set while recording or while the thumbnail screen is displayed.</li> <li>This cannot be set while using Slow &amp; Quick Motion or Cache Recording mode</li> <li>This cannot be set if the video format is set to “HD420 HQ/720/23.98P” (for UDF) or “SP 1440/23.98P” (for FAT).</li> </ul>
	<b>EX Slow Shutter</b> (PMW-200 only) Specifying operating conditions of the Supersensitized Slow Shutter mode. Unselectable while recording, while i.Link output is enabled in the SDI/HDMI/i.LINK I/O Select, while Picture Cache Recording mode is set or while Slow & Quick Motion mode is set.	Setting On / Off
	Number of Frames <b>16</b> / 32 / 64	Set the number of frames to accumulate.
<b>MF Assist</b> Turning the MF Assist Function on/off	On / Off	Set to “On” to precisely adjust the focus automatically after you roughly adjust it manually.
<b>Color Bars</b> Setting the Color Bars	Camera/Bars <b>Camera</b> / Bars	Select “Bars” to output color bars.
	Bars Type <b>Multi</b> / 75% / 100% / SMPTE	Select the type of color bar to be output when “Bars” is selected. Multi: Multiformat color bars are output. 75%: To output 75% color bars 100%: To output 100% color bars SMPTE: To output SMPTE color bars.

## CAMERA SET

Menu items	Subitems and setting values	Contents
<b>Flicker Reduce</b> Setting Flicker Compensation	Mode Auto / On / <b>Off</b>	Set the operation of the Flicker-Reduction function. On: To always activate it Auto: To automatically activate it when flicker is detected. Off: To not activate it
	Frequency 50 Hz / 60 Hz <b>60 Hz:</b> UC model <b>50 Hz:</b> Other models	Set to the power supply frequency of the light source causing flicker.
<b>Zoom Speed</b> Setting the zoom speed	High 1 to 99 ( <b>70</b> )	Set the speed of zooming to be executed when you press the handle ZOOM button with the zoom speed switch set to H.
	Low 1 to 99 ( <b>30</b> )	Set the speed of zooming to be executed when you press the handle ZOOM button with the zoom speed switch set to L.
	Remote 1 to 99 ( <b>50</b> )	Set the speed of zooming to be executed when you press the ZOOM button of the IR Remote Commander.
<b>Zoom Transition</b> Setting the zoom operation mode	<b>Linear</b> / Soft	Set the operation mode at the beginning and end of zooming with the on-handle ZOOM button. Set the operation mode at the beginning and end of zooming with the handle ZOOM button. Linear: Zooming immediately begins at the specified speed when the ZOOM button is pressed and immediately ends when the button is released. Soft: Zooming gradually increases the speed up to the specified speed after the ZOOM button is pressed and gradually decreases the speed and ends after the button is released. (1 second at maximum from when the button is released till the operation ends.)

### Notes

- It is recommended to set this to “Off” when shooting outdoors or under lighting that does not cause flicker. (It can be also “Auto,” but the compensation may not be done properly.)
- It is recommended to set this to “Auto” when shooting indoors or under various lighting that may cause flicker, such as fluorescent, sodium, or mercury-vapor lamps. (If continuously shooting under lighting that may cause flicker, “Mode” should be set to “On.”)

### Note

Zooming may not operate smoothly if you select a low speed.

### Note

If the infrared line from the Remote Commander is not received properly, zooming may not operate smoothly.

### Note

If “Zoom Speed” is set to a value less than 20, the operation becomes the same as “Linear,” even when “Soft” is selected.

CAMERA SET		
Menu items	Subitems and setting values	Contents
<b>Interval Rec</b> Setting the Interval Recording function	Setting On / Off	Turn the Interval Recording function on/off.
	Interval Time 1 to 10/15/20/30/40/50 sec 1 to 10/15/20/30/40/50 min 1 to 4/6/12/24 hour	Set the interval of recording in Interval Recording.
<b>Frame Rec</b> Setting the Frame Recording function	Setting On / Off	Turn the Frame Recording function on/off.
	Number of Frames 1 / 3 / 6 / 9 or 2 / 6 / 12 (When using 720/ 59.94P or 720/50P)	Set the number of frames to be recorded at a time in Interval Recording.
<b>Clip Cont. Rec</b> Setting the Clip Continuous Recording function	Setting On / Off	Turn the Clip Continuous Recording function on/off.
	Number of Frames 1 / 3 / 6 / 9 or 2 / 6 / 12 (When using 720/ 59.94P or 720/50P)	Set the number of frames to be recorded at a time in Frame Recording.
<b>P.Cache Rec</b> Setting the Picture Cache Recording function	Setting On / Off	Turn the Picture Cache Recording function on/off.
	Rec Time 0-2sec / 2-4sec / 4-6sec / 6-8sec / 8-10sec / 13-15sec	Set the time to cache video in the picture cache memory (the time to a point where recording is to start when you press the REC START/STOP button in Picture Cache Recording).
<b>S&amp;Q Motion</b> Setting the Slow & Quick Motion function Unselectable while “EX Slow Shutter” is set (PMW-200 only).	Setting On / Off	Turn the Slow and Quick Motion function on/off.
	Frame Rate 1 to 60 (NTSC: <b>30</b> , PAL: <b>25</b> )	Set the recording frame rate for Slow & Quick Motion mode. The setting value range varies depending on the selection region and video format.
<b>Rec Review</b> Setting the playback time for Rec-Review	3 sec / 10 sec / Clip	Set the time to play the last recorded clip using the Rec-Review function. 3 sec: Last 3 seconds 10 sec: Last 10 seconds Clip: Entire duration of the clip

## CAMERA SET

Menu items	Subitems and setting values	Contents
<b>TLCS</b> Setting the Total Level Control System (auto adjustment system of gain, exposure and shutter)	Level +1.0 / +0.5 / <b>±0</b> / -0.5 / -1.0	Set the target level (to make brighter or darker) of auto iris (PMW-200)/auto exposure (PMW-100) control in TLCS. (This setting also affects the gain control in AGC mode and shutter-speed control in Auto Shutter mode.) +1.0: Approx. one stop further open +0.5: Approx. half a stop further open ±0: Standard -0.5: Approx. half a stop further closed -1.0: Approx. one stop further closed
	Mode Backlight / <b>Standard</b> / Spotlight	Set the auto iris (PMW-200)/auto exposure (PMW-100) control mode in TLCS. Backlight: Backlight mode to reduce darkening of the center subject against lights Standard: Standard mode Spotlight: Spotlight mode to reduce blown-out highlights on the center subject in the spotlight
	Speed -99 to +99 ( <b>+50</b> )	Set the tracing speed of TLCS control.
	AGC On / <b>Off</b>	Turn the AGC (Auto Gain Control) function on/off.
	AGC Limit 3 / 6 / 9 / <b>12</b> / 18 dB	Set the maximum gain in AGC.
	AGC Point PMW-200: <b>F2.8</b> / F4 / F5.6 PMW-100: <b>E98</b> / E95 / E92	PMW-200: Set the iris point for switching to auto-iris and AGC (Auto Gain Control) control when AGC is on. PMW-100: Set the exposure position for switching to auto exposure and AGC (Auto Gain Control) control when AGC is on.
	Auto Shutter On / <b>Off</b>	Turn the Auto Shutter control function on/off.
	A.SHT Limit PMW-100: 1/100 1/125 1/250 <b>1/500</b> PMW-200: 1/100 1/150 1/200 <b>1/250</b>	Set the maximum shutter speed in Auto Shutter control.
	A.SHT Point PMW-200: F5.6 / F8 / F11 / <b>F16</b> PMW-100: <b>E87</b> / E82 / E77 / E72	Set the exposure position for switching auto iris (PMW-200)/ auto exposure (PMW-100) and auto shutter control when Auto Shutter is on.
	<b>Shockless White</b> Setting the shockless white balance	Off / 1 / <b>2</b> / 3 Select the speed of change in white balance when the white balance mode is switched. Set to "Off" to instantly change the white balance. Select a larger number to change the white balance more slowly through interpolation.
<b>White Switch &lt;B&gt;</b> Setting for the WHITE BAL switch	<b>ATW</b> / MEM Select the white balance adjustment mode selected at the B position of the WHITE BAL switch.	

CAMERA SET		
Menu items	Subitems and setting values	Contents
<b>ATW Speed</b> Setting for Auto Tracing White Balance	1 / 2 / 3 / 4 / 5	Set the tracing speed of ATW. The larger the number you set, the speed becomes faster.
<b>Wide Conversion</b> Setting for use of a wide-conversion lens	On / Off	Set to "On" when a wide-conversion lens is attached.
<b>Steady Shot</b> Setting the image stabilizer	On / Off	Turn the Steady Shot (image stabilizer) function on/off.
<b>Image Inversion</b> (PMW-200 only) Setting the image inversion function	<b>Normal</b> / H INV / V INV / H+V	Normal: Normal image direction H INV: To horizontally invert the image V INV: To vertically invert the image H+V: To horizontally and vertically invert the image
		<p><b>Notes</b></p> <ul style="list-style-type: none"> <li>• This cannot be set while recording, while the color bars are displayed or while using Recording Review.</li> <li>• This cannot be set while the automatic black balance function is set.</li> </ul>
<b>NightShot</b> (PMW-100 only) Setting the NightShot function	Setting On / <b>Off</b> NS Light <b>Auto</b> / Off	Turn the NightShot function on/off.  Set the NightShot infrared line to emit automatically when the "NightShot" function is set to "On."
<b>Exposure</b> (PMW-100 only) Setting the Exposure function	<b>Auto</b> / Manual	Select whether to set Exposure automatically or manually.
		<p><b>Note</b></p> <p>This cannot be selected when the "NightShot" function is set to "On."</p>
<b>Auto Black Bal.</b> Setting the automatic black balance	<b>Execute</b> / Cancel	Turn the automatic black balance function on/off.
		<p><b>Notes</b></p> <ul style="list-style-type: none"> <li>• This cannot be set while recording or while the color bars are displayed.</li> <li>• This cannot be set while using the Picture Cache Recording mode, the Interval Recording mode, the Frame Recording mode, the Slow and Quick Motion mode, the Slow Shutter mode or the Supersensitized Slow Shutter mode.</li> </ul>

# AUDIO SET Menu

## AUDIO SET

Menu items	Subitems and setting values	Contents
<b>Audio Input</b> Setting for audio inputs 	CH3 Input Source <b>Internal</b> / External	Set the audio signal source to be recorded for CH3 for a 4-channel recordable format. Internal: Record the L side of the internal microphone for CH3. External: Record the AUDIO IN CH1 signal for CH3.
	CH4 Input Source <b>Internal</b> / External	Set the audio signal source to be recorded for CH4 for a 4-channel recordable format. Internal: Record the R side of the internal microphone for CH4. External: Record the AUDIO IN CH2 signal for CH4.
	EXT MIC CH1 Ref -70 dB / -60 dB / -50 dB / <b>-40 dB</b> / -30 dB	Select the reference input level when an external microphone is connected to the AUDIO IN CH1 connector and that signal is being used for the audio signal source for CH1 or CH3. This can be selected regardless of the setting of the AUDIO SELECT switch.
	<div style="text-align: center;"><b>Note</b></div> <p>This is unavailable when the AUDIO IN CH-1 switch is set to INT and “CH3 Input Source” is set to “Internal.” This is also unavailable when the CH-1 input (LINE/MIC/MIC+48V) switch is set to LINE.</p>	
	EXT MIC CH2 Ref -70 dB / -60 dB / -50 dB / <b>-40 dB</b> / -30 dB	Select the reference input level when an external microphone is connected to the AUDIO IN CH2 connector and that signal is being used for the audio signal source for CH2 or CH4. This can be selected regardless of the setting of the AUDIO SELECT switch.
	<div style="text-align: center;"><b>Note</b></div> <p>This is unavailable when the AUDIO IN CH-2 switch is set to INT and “CH4 Input Source” is set to “Internal.” This is also unavailable when the CH-2 input (LINE/MIC/MIC+48V) switch is set to LINE.</p>	
	INT MIC Level -12 dB / -6 dB / <b>0 dB</b> / +6 dB / +12 dB	Select the internal microphone level. This can be selected regardless of the AUDIO SELECT switch setting.
	Limiter Mode <b>Off</b> / -6 dB / -9 dB / -12 dB / -15 dB / -17 dB	Select whether to activate the limiter when a loud signal is input while the AUDIO SELECT switch is set to MANU (manual).
	AGC Spec <b>-6 dB</b> / -9 dB / -12 dB / -15 dB / -17 dB	Select the audio input level AGC.
CH1&2 AGC Mode Mono / <b>Stereo</b>	Select auto tuning for the input level of an analog audio signal recorded to CH-1/CH-2. Mono: Perform for each channel. Stereo: Perform in stereo mode.	

## AUDIO SET

Menu items	Subitems and setting values	Contents
	CH3&4 AGC Mode <b>Mono</b> / Stereo / Off	Select auto tuning for the input level of an analog audio signal recorded to CH-3 or CH-4. Mono: Perform for each channel. Stereo: Perform in stereo mode. Off: Do not perform auto tuning. The Limiter Mode setting is applied.
	1KHz Tone On / <b>Off</b>	Turn the 1-kHz reference tone signal on/off.
	Wind Filter CH-1 On / <b>Off</b>	Turn the wind filter for CH1 on/off.
	Wind Filter CH-2 On / <b>Off</b>	Turn the wind filter for CH2 on/off.
	Wind Filter CH-3 On / <b>Off</b>	Turn the wind filter for CH3 on/off.
	Wind Filter CH-4 On / <b>Off</b>	Turn the wind filter for CH4 on/off.
	EXT CH Select CH-1 <b>CH-1/CH-2</b>	CH-1: To record the CH1 external input signal to both CH1 and CH2 (when the CH-2 AUDIO IN switch is set to EXT). If "CH4 Input Source" is set to "External," you can also record to CH4. CH-1/CH-2: To record each external input signal to its respective channel.
<b>Audio Output</b> Setting for audio outputs	Monitor CH <b>CH-1/CH-2 (CH-3/CH-4)</b> CH-1+CH-2 (CH-3+CH-4) CH-1 (CH-3) CH-2 (CH-4)	Select the audio channel(s) to be fed to the headphones and the built-in speaker. CH-1/CH-2 (CH-3/CH-4): Stereo CH-1+CH-2 (CH-3+CH-4): Mix CH-1 (CH-3): CH-1 (CH-3) only CH-2 (CH-4): CH-2 (CH-4) only ( ): with Output CH set to "CH-3/CH-4"
	Output CH <b>CH-1/CH-2</b> CH-3/CH-4	Select audio output channels from either channels 1 and 2 or channels 3 and 4.
	Alarm Level 0 to 7 ( <b>4</b> )	Set the alarm sound volume.
	Beep On / <b>Off</b>	Select whether or not to sound a beep upon each operation.

## VIDEO SET Menu

### VIDEO SET

Menu items	Setting values	Contents
<b>Input Source Select</b> Setting the input source	<b>Camera / i.LINK</b>	Select video and audio signal for the input source. Camera: Camera image i.LINK: HDV/DVCAM input via the i.LINK (HDV/DV) connector
		<b>Notes</b> <ul style="list-style-type: none"> <li>i.LINK is unavailable when using UDF.</li> <li>DVCAM is for display only and cannot be recorded.</li> </ul>
<b>SDI/HDMI/i.LINK I/O Select</b> Selecting input/output signals for the connectors	When using UDF HD Mode <b>HD SDI &amp; HD HDMI</b> SD SDI & SD HDMI i SD HDMI P Off When using FAT HD Mode (HQ) <b>HD SDI &amp; HD HDMI</b> SD SDI & SD HDMI i SD HDMI i & DVCAM SD HDMI P Off When using FAT HD Mode (SP) <b>HD SDI &amp; HD HDMI</b> SD SDI & SD HDMI i HD HDMI & HDV SD HDMI i & HDV SD HDMI P & HDV SD HDMI i & DVCAM Off When using UDF SD Mode <b>SD SDI &amp; SD HDMI i</b> Off When using FAT SD Mode <b>SD SDI &amp; SD HDMI i</b> SD HDMI i & DVCAM Off	HD SDI & HD HDMI: To output HD SDI signals from the SDI OUT connector, and HD HDMI signals from the HDMI OUT connector. SD SDI & SD HDMI i: To output SD SDI signals from the SDI OUT connector, and SD HDMI interlace signals from the HDMI OUT connector. HD HDMI & HDV: To output HD HDMI signals from the HDMI OUT connector, and input/output HDV streams from the i.LINK (HDV/DV) connector. SD HDMI i & HDV: To output SD HDMI interlace signals from the HDMI OUT connector, and input/output HDV streams from the i.LINK (HDV/DV) connector. SD HDMI P & HDV: To output SD HDMI progressive signals from the HDMI OUT connector, and input/output HDV streams from the i.LINK (HDV/DV) connector. SD HDMI i & DVCAM: To output SD HDMI interlace signals from the HDMI OUT connector, and input/output DVCAM streams from the i.LINK (HDV/DV) connector. SD HDMI P: To output SD HDMI progressive signals from the HDMI OUT connector. Off: There is no output from the SDI/HDMI/i.LINK connectors.
		<b>Notes</b> <ul style="list-style-type: none"> <li>Signals are not output from the SDI OUT connector when this is set to other than an HD SDI or SD SDI setting.</li> <li>Slow &amp; Quick Motion mode cannot be used when this is set to input/output DVCAM streams.</li> </ul>
<b>SDI/HDMI/Video Out Super</b> Setting the character information for each output	<b>On / Off</b>	Set whether to add the menus and status indications of the LCD monitor/EVF screen to the output of the SDI OUT, HDMI OUT, VIDEO OUT, and A/V OUT connectors.
		<b>Note</b> On the thumbnail, EXPAND CLIP and SHOT MARK screens, the menus and status indications on the LCD monitor/EVF screen are displayed regardless of the setting of this item.







VIDEO SET		
Menu items	Setting values	Contents
<b>Down Converter</b> Selecting the operation mode of the down converter	<b>Squeeze</b> / Letterbox / Edge Crop	Set the output mode (aspect) for SD signals Squeeze: To horizontally reduce a 16:9 picture to output a 4:3 picture Letterbox: To mask the upper and lower areas of a 4:3 picture to display a 16:9 picture in the center of the screen Edge Crop: To cut the both sides of a 16:9 picture to output a 4:3 picture
<b>23.98P Output</b> Selecting Output mode	<b>59.94i (2-3 Pull Down)/</b> 23.98PsF	Select the video output format when the video format for UDF HD Mode is HD422 50/1080/23.98P, HD420 HQ/1080/23.98P, HD422 50/720/23.98P, HD420 HQ/720/23.98P, or the video format for FAT HD Mode is HQ 1920/23.98P or HQ 1440/23.98P.
<b>SDI Rec Control</b> Setting the synchronized recording	<b>Off</b> / HD SDI Remote I/F	To turn the function to enabling recording synchronized with this camcorder. HD SDI Remote I/F: To feed a REC trigger signal to a recorder connected to the SDI OUT connector.

## LCD/VF SET Menu

LCD/VF SET			
Menu items	Subitems and setting values	Contents	
<b>LCD</b> Adjusting the LCD monitor	Color -99 to +99 ( $\pm 0$ )	Adjust the color of pictures on the LCD monitor.	
	Contrast -99 to +99 ( $\pm 0$ )	Adjust the contrast of pictures on the LCD monitor.	
	Brightness -99 to +99 ( $\pm 0$ )	Adjust the brightness of pictures on the LCD monitor.	
<b>EVF</b> Setting the viewfinder	Backlight <b>High</b> / Low	Select the brightness of the EVF backlight.	
	Mode <b>Color</b> / B&W	Select the display mode of the EVF while recording (or standing by to record). Color: Color mode B&W: Monochrome mode	
	Contrast -99 to +99 ( $\pm 0$ )	Adjust the contrast of pictures on the EVF screen.	
	Brightness -99 to +99 ( $\pm 0$ )	Adjust the brightness of pictures on the EVF screen.	
	Power <b>Auto</b> / On	Set the condition to turn the EVF on. Auto: To turn it on when the LCD monitor is closed or rotated to the upside-down position. On: To keep it on regardless of the status of the LCD monitor.	
	<b>Peaking</b> Setting the peaking function for the LCD monitor/EVF	Setting On / <b>Off</b>	Turn the peaking function on/off.
	<input type="checkbox"/>	Color <b>White</b> / Red / Yellow / Blue	Select the color of the peaking signal.
	Level High / <b>Mid</b> / Low	Set the level of the peaking signal.	

## LCD/VF SET

Menu items	Subitems and setting values	Contents
<b>Marker</b> Setting the markers added to pictures on the LCD monitor/EVF screen 	Setting <b>On / Off</b>	Turn all marker indications on/off in combination.
	Safety Zone <b>On / Off</b>	Turn the safety marker on/off.
	Safety Area 80% / <b>90%</b> / 92.5% / 95%	Select the size (ratio to the entire screen) of the safety zone marker.
	Center Marker <b>On / Off</b>	Turn the center marker on/off.
	Aspect Marker Line / Mask / <b>Off</b>	Select the aspect marker. Line: To show white lines Mask: To lower the video signal level of areas outside the marker range. Off: To not display
	<b>Note</b>	
	No aspect marker is displayed when a video format of EC (Edge Crop) is selected in SD Mode.	
	Aspect Select <b>4:3</b> / 13:9 / 14:9 / 15:9 / 1.66:1 / 1.85:1 / 2.35:1 / 2.4:1	Select the ratio of the aspect marker.
	Aspect Mask 90% / 80% / 70% / 60% / 50% / 40% / 30% / 20% / 10% / <b>0%</b>	When "Aspect Marker" is "Mask," select the brightness of images outside the aspect marker.
	Guide Frame <b>On / Off</b>	Turn the guide frame marker on/off.
<b>Zebra</b> Setting the zebra pattern 	Setting <b>On / Off</b>	Turn the zebra function on/off.
	Zebra Select <b>1</b> / 2 / Both	Select the zebra pattern(s) to be displayed. 1: To display only Zebra1 (the default is 70%) for an area within $\pm 10\%$ of the "Zebra1 Level" video level. 2: To display only Zebra2 (the default is 100%) for a video level over 100%. Both: To display both zebra 1 and zebra 2
	Zebra1 Level 50 to 107 ( <b>70</b> )	Set the display level of zebra 1.
	<b>Display On/Off</b> Selecting the items to be displayed on the LCD monitor/EVF screen 	Video Level Warnings <b>On / Off</b>
<b>Display On/Off</b> Selecting the items to be displayed on the LCD monitor/EVF screen 	Brightness Display <b>On / Off</b>	Turn the numeric indication to show the picture brightness on/off.
	Histogram Display <b>On / Off</b>	Turn the histogram indication to show the level distribution of the picture on/off.
	Lens Info Meter / Feet / <b>Off</b>	Select the depth-of-field indication. Meter: To indicate in meters Feet: To indicate in feet Off: To not indicate
	Zoom Position <b>Number</b> / Bar / Off	Select the type of zoom position indication. Number: Indication with a number Bar: Indication with a bar Off: To not display
	Audio Level Meter <b>On / Off</b>	Turn the audio level meter indication on/off.

**LCD/VF SET**

<b>Menu items</b>	<b>Subitems and setting values</b>	<b>Contents</b>
	Timecode <b>On / Off</b>	Turn the time data (timecode, user bits, duration) indication on/off.
	Battery Remain <b>On / Off</b>	Turn the battery remaining/DC input voltage indication on/off.
	Media Remain <b>On / Off</b>	Turn the media remaining indication on/off.
	TLCS Mode <b>On / Off</b>	Turn the TLCS mode indication on/off.
	Steady Shot <b>On / Off</b>	Turn the Steady Shot indication on/off.
	Focus Mode <b>On / Off</b>	Turn the focus operation mode indication on/off.
	White Balance Mode <b>On / Off</b>	Turn the white balance mode indication on/off.
	Picture Profile <b>On / Off</b>	Turn the Picture Profile indication on/off.
	Filter Position (PMW-200 only) <b>On / Off</b>	Turn the ND filter setting indication on/off.
	Iris Position (PMW-200 only) <b>On / Off</b>	Turn the iris setting indication on/off.
	Exposure Position (PMW-100 only) <b>On / Off</b>	Turn the exposure indication on/off.
	Gain Setting <b>On / Off</b>	Turn the gain setting indication on/off.
	Shutter Setting <b>On / Off</b>	Turn the shutter mode and speed indication on/off.
	Rec Mode <b>On / Off</b>	Turn the special recording mode (Frame Rec, Interval Rec, S&Q Motion) indication on/off.
	Video Format <b>On / Off</b>	Turn the video format indication on/off.
	Clip Name <b>On / Off</b>	Turn the clip name display on/off.
	ClipNumber (PB) <b>On / Off</b>	Turn the clip number display on/off.
	NightShot (PMW-100 only) <b>On / Off</b>	Turn the NightShot display on/off.
	SDI Rec Control <b>On / Off</b>	Turn the synchronous recording display (the Rec2 display) on/off.
	Wide Conversion <b>On / Off</b>	Turn the wide Conversion setting indication on/off.

## TC/UB SET Menu

### TC/UB SET

Menu items	Subitems and setting values	Contents	
<b>Timecode</b> Setting the timecode	Mode <b>Preset</b> / Regen / Clock	Set the timecode mode. Preset: To start the timecode from the specified value Regen (regeneration): To continue the timecode during recording only. When you insert another SxS memory card, the camcorder starts next recording so that the timecode continues from the last recorded timecode on the card. Clock: To use the current clock time as the timecode	
	Run <b>Rec Run</b> / Free Run	Set the running mode when the timecode mode is set to "Preset." Rec Run: To advance the timecode during recording only. The continuity of the timecode is maintained between clips in the sequence of recording as long as the SxS memory card is not changed. If you remove the memory card and record on another card, the timecode will not continue when you return the first card to the slot again. Free Run: The timecode keeps advancing regardless of the state of recording to the SxS memory card.	
	Setting	Set the timecode to a desired value.	
	Reset Execute / Cancel	Select "Execute" to reset the timecode to 00:00:00:00.	
	TC Out <b>Auto</b> / Generator	Select the timecode output. Auto: To output the timecode generator value during recording, and the timecode reader value during playback. Generator: To output the timecode generator value during recording or playback.	
	<b>Users Bit</b> Setting the user bits	Mode <b>Fix</b> / Date	Set the user bit mode. Fix: To use a desired fixed value as the user bits Date: To use the current date
		Setting	Set the user bits to a desired value.

#### Notes

- In Interval Recording, Frame Recording and Slow & Quick Motion Recording, if you set "Mode" to "Preset" the timecode advances in Rec Run mode regardless of the "Run" setting. If you set it to "Clock," the timecode advances in Regen mode.
- When the Picture Cache function (*page 50*) is active ("Setting" of "P.Cache Rec" is set to "On"), the timecode always advances in Free Run mode. When the Picture Cache Recording function is deactivated, the running mode is restored to the selected mode.

TC/UB SET		
Menu items	Subitems and setting values	Contents
<b>TC Format</b> Setting the time code format	<b>DF / NDF</b>	Set the timecode format. DF: Drop frame NDF: Non drop frame
<p style="text-align: center;"><b>Note</b></p> <p>The current video format/frame frequency determines whether the mode is fixed either to DF or NDF (see below), regardless of the TC Format setting.</p>		
<b>Video formats</b>	<b>Frame setting</b>	<b>TC Format</b>
59.94i	00 to 29	DF/NDF
59.94P		switchable
29.97P		(Fixed to DF in
23.98P <sup>1)</sup>		Clock mode)
SP 1440/23.98P		
HD420 HQ/720/23.98P		
23.98P	00 to 23 <sup>2)</sup>	Fixed to NDF <sup>3)</sup>
HQ 1920/23.98P		
HQ1440/23.98P		
HQ 1280/23.98P		
HD422 50/1080/23.98P		
HD420 HQ/1080/23.98P		
HD422 50/720/23.98P		
50i	00 to 24	Fixed to NDF
50P		
25P		

1) With DF, the frame digits can be set as desired in the range of 00 to 29.

With NDF, the frame at the beginning of recording is limited to 00, 05, 10, 15, 20, or 25.

2) The frame digits in "Setting" is limited to 00, 04, 08, 12, 16, and 20.

The frame at the beginning of recording is limited to 00, 04, 08, 12, 16, or 20.

As "23.98P Output" (page 89) in the VIDEO SET menu becomes 2-3 pull-down 59.94i when recording (or standing by to record) HQ 1920/23.98P other than when "23.98PsF" is selected, the overlapping timecodes of frames output from the SDI OUT connector are renumbered from 00 to 29.

3) Even in Clock mode, the timecode is gradually shifted, because it is counted by NDF.

As output from the SDI OUT connector becomes 2-3 pulled-down video when recording (or standing by to record) HQ 1920/23.98P and other than "23.98PsF" is selected for "23.98P Output" (page 89) in the VIDEO SET menu, fields are created in which overlapping timecodes are displayed on the screen.

## OTHERS Menu

### OTHERS

Menu items	Subitems and setting values	Contents
<b>All Reset</b> Resetting to the factory status	Execute/Cancel	Select "Execute" to reset the camcorder to the factory status.
<b>Camera Data</b> Storing/recalling the menu settings	Store Execute/Cancel	When you select "Execute" to store the setting values, the setup file is stored to one of the following directories. For UDF: /General/Sony/PRO/CAMERA/XDCAM/PMW_XXX/ For FAT: /SONY/PRO/CAMERA/XDCAM_EX/PMW_XXX/
	Recall Execute/Cancel	Select "Execute" to retrieve the setting values from an SxS memory card.
<b>Time Zone</b> Setting the time difference	UTC -12:00 to +13:30	Set the time-zone difference from UTC in steps of 30 minutes.  <b>Note</b> The default setting is different among the sales areas. United States and Canada: -5:00 Europe area: 0:00 Oceania: +10:00
<b>Clock Set</b> Setting the built-in clock	Date/Time	Set the current time and date.
	12H/24H 12H / <b>24H</b>	Select the display mode of time. 12H: 12-hour mode 24H: 24-hour mode
	Date Mode <b>YYMMDD</b> / MMDDYY / DDMMYY	Select the display mode of the date. YYMMDD: In sequence of year, month, day MMDDYY: In sequence of month, day, year DDMMYY: In sequence of day, month, year
<b>Language</b> Selecting the language for menus and messages	<b>English</b> / Japanese/Chinese	English: To display in English Japanese: To display in Japanese Chinese: To display in Chinese  <b>Note</b> "Japanese" is effective only on messages for warning and caution. The menus and status indications do not change.

## OTHERS

Menu items	Subitems and setting values	Contents
<b>Assign Button</b>	PMW-100: <1> to <4>	Assign a function to the ASSIGN buttons 1/2/3/4. (The
Assigning	PMW-200: <1> to <5>	selectable functions are shared.)
functions to the	Off / Zebra / Peaking / Marker /	Off: No function
assignable buttons	Last Clip DEL / ATW / ATW	Zebra: For turning the zebra function on/off
	Hold / Rec Review / Rec /	Peaking: For turning the peaking function on/off
	Picture Cache / Freeze Mix /	Marker: For turning the safety zone, center marker, aspect
	Expanded Focus / Spotlight /	marker and guide frame functions on/off as a group
	Backlight / IR Remote / Shot	Last Clip DEL: For executing the last clip delete (retake)
	Mark1 / Shot Mark2 / VF Mode	function
	/ BRT Disp / Histogram / Lens	ATW: For turning the ATW function on/off
	Info / OK Mark / NightShot	ATW Hold: For turning the ATW hold function on/off
	(PMW-100 only) / Clip Flag OK	Rec Review: For executing the recording review function
	/ Clip Flag NG / Clip Flag Keep	Rec: For starting/stopping recording
	/ Clip Continuous Rec / LCD/	Picture Cache: For turning the Picture Cache Recording
	VF Adjust / Exposure (PMW-	function on/off
	100 only) / Color Bars / One	Freeze Mix: For executing the freeze mix function
	Push AE (PMW-100 only) / One	Expanded Focus: For turning the expanded focus function on/
	Push Auto Iris (PMW-200 only)	off
	<1> <b>Zebra</b>	Spotlight: For enabling and disabling TLCS Spotlight mode
	<2> <b>Peaking</b>	Backlight: For enabling and disabling TLCS Backlight mode
	<3> <b>Off</b>	IR Remote: For activating/deactivating the IR Remote
	<4> <b>Off</b>	Commander
	<5> <b>Off</b> (PMW-200 only)	Shot Mark1: For adding shot mark 1 (HD Mode only)
		Shot Mark2: For adding shot mark 2 (HD Mode only)
		VF Mode: For switching between color and monochrome for
		the EVF screen
		BRT Disp: For turning the brightness level indication function
		on/off
		Histogram: For turning the histogram indication function on/
		off
		Lens Info: For switching the depth-of-field indication to
		“Off”/“Meter”/“Feet”
		OK Mark: For adding or removing an OK mark (HD Mode
		only, not valid via the thumbnail screen)
		NightShot (PMW-100 only): For turning the “NightShot”
		function on/off
		Clip Flag OK: For enabling and disabling OK flags for clips
		during recording and playback (UDF only)
		Clip Flag NG: For enabling and disabling NG flags for clips
		during recording and playback (UDF only)
		Clip Flag Keep: For enabling and disabling Keep flags for
		clips during recording and playback (UDF only)
		Clip Continuous Rec: For turning the Clip Continuous
		Recording function on/off
		LCD/VF Adjust: For switching the LCD/VF Adjust function
		level bar indication (LCD brightness adjustment → LCD
		contrast adjustment → VF brightness adjustment → VF
		contrast adjustment → off )
		Exposure (PMW-100 only): For switching the exposure
		function between “Auto”/“Manual”
		Color Bars: For switching between the color bar and camera
		signal
		One Push AE (PMW-100 only): For executing the One Push
		AE function
		One Push Auto Iris (PMW-200 only): For executing the One
		Push iris function.

OTHERS		
Menu items	Subitems and setting values	Contents
<b>Tally</b> Setting the tally lamps	Front	Set the brightness of the tally lamp.
	<b>High</b> / Low / Off	High: To brighten the lamp Low: To dim the lamp Off: To not light the lamp
<b>Hours Meter</b> Displaying the hours meter	Hours (Sys)	The non-resettable accumulated time of use is displayed.
	Hours (Reset)	The resettable accumulated time of use is displayed.
	Reset Execute/Cancel	Select "Execute" to reset the Hours (Reset) value to 0.
<b>IR Remote</b> Activating/ deactivating the Remote Commander	<b>On / Off</b>	Set to "On" to activate remote control operations from the supplied IR Remote Commander.
		<b>Note</b> The setting automatically returns to "Off" when the camcorder is turned off.
<b>Battery Alarm</b> Setting the low power alarm	Low BATT 5% / <b>10%</b> / 15% / ... / 45% / 50%	Set the battery level at which the Low BATT warning is generated (in steps of 5%).
	BATT Empty 3% to 7% ( <b>3%</b> )	Set the battery level at which the BATT Empty warning is generated.
	DC Low Volt1 11.5 V to 17.0 V ( <b>11.5 V</b> )	Set the DC IN voltage at which the DC Low Volt1 warning is generated.
	DC Low Volt2 11.0 V to 14.0 V ( <b>11.0 V</b> )	Set the DC IN voltage at which the DC Low Volt2 warning is generated.
<b>Battery INFO</b> Showing information regarding the battery pack (display only)	Type	The type (product name) is displayed.
	MFG Date	The date of manufacture is displayed.
	Charge Count	The accumulated number of times of charge/discharge is displayed.
	Capacity	The estimated total capacity of full charge is displayed.
	Voltage	The current output voltage is displayed.
	Remaining	The current remaining level is displayed.
<b>Genlock</b> Setting Genlock operation	H Phase (HD) -999 to +999 ( <b>±0</b> )	Set the H phase (phase of the horizontal sync signal) of HD signal for Genlock operation.
	H Phase (SD) -99 to +99 ( <b>±0</b> )	Set the H phase (phase of the horizontal sync signal) of SD signal for Genlock operation.
<b>Direct Menu</b> Setting the Direct menu function	All / <b>Part</b> / Off	All: All Direct menu operations are permitted. Part: A part of Direct menu operations is permitted. The operation is limited depending on the GAIN, SHUTTER, or WHITE BAL switch setting. Off: No Direct menu operation is permitted.
<b>Trigger Mode</b> Setting for operating an external recording device connected via the i.LINK connector (FAT only)	Internal / <b>Both</b> / External	Internal: To activate recording start/stop operations only for an SxS memory card in a built-in slot. Both: To activate recording start/stop operations both for an SxS memory card in a built-in slot and the external recording device connected via the i.LINK connector. External: To activate recording start/stop operations only for the external recording device connected via the i.LINK connector.



**OTHERS**

Menu items	Subitems and setting values	Contents	
<b>System</b>	Country	Select the area of use and setup ON/OFF setting.	
	<b>NTSC Area</b> / NTSC(J) Area / PAL Area	NTSC Area: Setup ON NTSC(J) Area: Setup OFF PAL Area: Setup OFF	
		<b>Note</b>	
		The default setting is different among the sales areas. United States and Canada: NTSC Area Other areas: PAL Area	
	UDF/FAT	Switch the file system between UDF/FAT.	
	<b>UDF</b> / FAT		
	HD/SD	Switch between HD Mode and SD Mode for recording/	
	<b>HD</b> / SD	playback.	
	Format	Select the video format for recording.	
	<ul style="list-style-type: none"> <li>• UDF HD Mode</li> <li>Country: NTSC Area/NTSC(J) Area</li> <li><b>HD422 50/1080/59.94i</b></li> <li>HD420 HQ/1080/59.94i</li> <li>HD422 50/1080/29.97P</li> <li>HD420 HQ/1080/29.97P</li> <li>HD422 50/1080/23.98P</li> <li>HD420 HQ/1080/23.98P</li> <li>HD422 50/720/59.94P</li> <li>HD420 HQ/720/59.94P</li> <li>HD422 50/720/29.97P</li> <li>HD422 50/720/23.98P</li> <li>HD420 HQ/720/23.98P</li> <li>Country: PAL Area</li> <li><b>HD422 50/1080/50i</b></li> <li>HD420 HQ/1080/50i</li> <li>HD422 50/1080/25P</li> <li>HD420 HQ/1080/25P</li> <li>HD422 50/720/50P</li> <li>HD420 HQ/720/50P</li> <li>HD422 50/720/25P</li> <li>• UDF SD Mode</li> <li>Country: NTSC Area/NTSC(J) Area</li> <li><b>DVCAM59.94i SQ</b></li> <li>DVCAM59.94i EC</li> <li>DVCAM29.97P SQ</li> <li>DVCAM29.97P EC</li> <li>Country: PAL Area</li> <li><b>DVCAM50i SQ</b></li> <li>DVCAM50i EC</li> <li>DVCAM25P SQ</li> <li>DVCAM25P EC</li> </ul>	<ul style="list-style-type: none"> <li>• FAT HD Mode</li> <li>Country: NTSC Area/NTSC(J) Area</li> <li><b>HQ 1920/59.94i</b></li> <li>HQ 1440/59.94i</li> <li>SP 1440/59.94i</li> <li>HQ 1920/29.97P</li> <li>HQ 1440/29.97P</li> <li>HQ 1920/23.98P</li> <li>HQ 1440/23.98P</li> <li>SP 1440/23.98P</li> <li>HQ 1280/59.94P</li> <li>HQ 1280/29.97P</li> <li>HQ 1280/23.98P</li> <li>Country: PAL Area</li> <li><b>HQ 1920/50i</b></li> <li>HQ 1440/50i</li> <li>SP 1440/50i</li> <li>HQ 1920/25P</li> <li>HQ 1440/25P</li> <li>HQ 1280/50P</li> <li>HQ 1280/25P</li> <li>• FAT SD Mode</li> <li>Country: NTSC Area/NTSC(J) Area</li> <li><b>DVCAM59.94i SQ</b></li> <li>DVCAM59.94i EC</li> <li>DVCAM29.97P SQ</li> <li>DVCAM29.97P EC</li> <li>Country: PAL Area</li> <li><b>DVCAM50i SQ</b></li> <li>DVCAM50i EC</li> <li>DVCAM25P SQ</li> <li>DVCAM25P EC</li> </ul>	<p><b>HD Mode</b></p> <ul style="list-style-type: none"> <li>• Bit rate</li> <li>UDF: HD422 50 or HD420 HQ</li> <li>FAT: HQ or SP</li> <li>• Horizontal resolution</li> <li>1920, 1440, or 1280</li> <li>• Frame rate</li> <li>23.98, 25, 29.97, 50, or 59.94</li> <li>• Scan system</li> <li>i (interlace) or P (progressive)</li> </ul> <p><b>SD Mode</b></p> <ul style="list-style-type: none"> <li>• Frame rate</li> <li>25, 29.97, 50, or 59.94</li> <li>• Scan system</li> <li>i (interlace) or P (progressive)</li> <li>• Aspect</li> <li>SQ (Squeeze) or EC (Edge Crop)</li> </ul>

**OTHERS**

Menu items	Subitems and setting values	Contents
<b>Clip</b> Setting for clip name or deletion	Auto Naming C**** / Title / <b>Plan</b>	Select the method to specify clip names. C****: UDF only Title: To specify as desired by “Title Prefix” Plan: To use a name specified in planning metadata (if no name is specified in planning metadata, the name specified by “Title Prefix” is used.)
	Title Prefix nnn_ (nnn=least three digits of the serial number) (Max. 7 characters displayed)	Call the Character Set screen to set the title part (4 to 46 characters) of the clip names. <b>Configuration of the Character Set screen</b> Character selection area (3 lines): To select a character to insert in the cursor position of the Title Prefix area. !#\$%()+,-.=@[^\_~0123456789 abcdefghijklmnopqrstuvwxy ABCDEFGHIJKLMNPOQRSTUVWXYZ Cursor operation area (1 line): Space: To change the character in the cursor position to a space INS: To insert a space in the cursor position DEL: To delete a character in the cursor position ←: To move the cursor to the left →: To move the cursor to the right ESC: To cancel the change and exit the Character Set screen END: To validate the change and exit the Character Set screen Title Prefix area (1 line): For entering the title <b>To set the title</b> 1 Using the up/down/left/right buttons, select (highlight) a character in the character selection area to be entered in the cursor position of the Title Prefix area. Then press the SEL/SET button or the jog dial. 2 Repeat Step 1 for setting the title. (Use Space, INS, and DEL as required.) 3 When the title setting is completed, select END to exit the Character Set screen.
	Number Set 0001 to 9999	Set the second 4-numeric part of the clip name.
	Update Media(A) / Media(B)	To update the managerial file on the SxS memory card in the selected slot. <sup>1)</sup>
	Last Clip DEL Execute / Cancel	Select “Execute” to delete the last recorded clip.
	All Clips DEL Execute / Cancel	Select “Execute” to delete all clips on the active SxS memory card. <b>Note</b> Clips to which you applied OK mark and clips that are locked cannot be deleted.
	Filter Clips OK / NG / KP / None	Select from among OK (the OK flag), NG (the not good flag), KP (the keep flag), or None (for no flag) to filter displayed clips. (UDF only)
	Lock All Clips Execute/Cancel	Select “Execute” to protect all clips. (UDF only)

OTHERS		
Menu items	Subitems and setting values	Contents
	Unlock All Clips Execute/Cancel	Select "Execute" to remove protection from all clips. (UDF only)
	Index Picture Pos 0sec to 10sec ( <b>0sec</b> )	Set the image for viewing thumbnails. This selects the time difference from the start of the clip.
	Find Mode <b>Clip</b> / Rec Start	Set the action for when you press the PREV button/NEXT button. (UDF only) Clip: Move to the start of the current clip/next clip. (Pressing the PREV button from the start of a clip will move to the start of the previous clip.) Rec Start: Move to the previous Rec Start Essence Mark/the next Rec Start Essence Mark.
<b>Copy All</b> <sup>2)</sup> Setting for collective copy of clips and/or General files	Clips	To copy all clips on an SxS memory card to the other.
	General Files	To copy all files in the General folder on an SxS memory card to the other.
	Clips&General	To copy all clips and files in the General folder on an SxS memory card to the other.
<b>Format Media</b> Formatting SxS memory cards	Media(A) Execute / Cancel	Select "Execute" to format the SxS memory card in slot A with the selected file system (UDF/FAT).
	Media(B) Execute / Cancel	Select "Execute" to format the SxS memory card in slot B with the selected file system (UDF/FAT).
<b>Plan.Metadata</b> Setting planning metadata	Load/Slot(A) or Load/Slot(B) Execute / Cancel	To load planning metadata from the SxS memory card in slot A or B. Selecting "Execute" displays the list of the planning metadata files stored on the SxS memory card in slot A or B. Specify a file, select "Load" then "Execute" for loading.
	Load/USB (PMW-200, in UDF mode only) Execute/Cancel	Loads planning metadata from the USB flash drive connected to the external device connector. Select "Execute" to show the list of the planning metadata files stored in the USB flash drive and select a file to be loaded.

#### Notes

- The file list displays up to 64 files. Even if the total number of planning metadata files is 64 or less, all of the planning metadata files may not appear if the directory where they are located in the SxS memory card (General/Sony/Planning) contains 512 or more files.
- After you start loading, do not remove the SxS memory card until the completion message is displayed.

**OTHERS**

Menu items	Subitems and setting values	Contents
	Properties Execute / Cancel	Select "Execute" to display the detailed information of the planning metadata loaded in the camcorder. File Name: Filename Assign ID: Assignment ID Created: Time and date of creation Modified: Time and date of most recent modification Modified by: Name of person who modified the file Title1: Title1 specified in file (clip name in ASCII format) Title2: Title2 specified in file (clip name in UTF-8 format) Material Gp: Number of material groups (groups of clips recorded using the same planning metadata) Shot Mark1: Name defined for Shot Mark 1 Shot Mark2: Name defined for Shot Mark 2 When you select "File Name," "Assign ID," "Title1," or "Title2" on the Planning Metadata Properties screen and then press the SEL/SET button or the jog dial, the selected item is displayed on the full screen, permitting you to check a long file or clip name at a glance.
		<b>Note</b> Names of shot marks cannot be displayed on the full screen even if you select Shot Mark 1 or Shot Mark 2.
	Clear Execute / Cancel	Select "Execute" to clear the planning metadata loaded in the camcorder.
	Clip Name Disp <b>Title1 (ASCII) / Title2 (UTF-8)</b>	Select the display mode of the clip name specified in planning metadata.
		<b>Note</b> When both an ASCII format name and a UTF-8 format name are specified in planning metadata, the UTF-8 format string is used as the clip name. If only either ASCII-format name or UTF-8 format name is specified in planning metadata, the specified name is displayed regardless of the menu setting.
<b>Network</b> (PMW-200 only) Setting for network connections	DHCP Enable / <b>Disable</b>	Select whether to acquire the IP address automatically from a DHCP server (Enable) or not (Disable).
	IP Address 0.0.0.0 to 255.255.255.255 <b>(192.168.1.10)</b>	Set the IP address when "DHCP" is set to "Disable."
	Subnet Mask 0.0.0.0 to 255.255.255.255 <b>(255.255.255.0)</b>	Set the subnet mask when "DHCP" is set to "Disable."
<b>Note</b> The CBK-WA01 Wi-Fi Adapter is required.	Default Gateway 0.0.0.0 to 255.255.255.255 <b>(0.0.0.0)</b>	Set the default gateway when "DHCP" is set to "Disable."
	User Name <b>(admin)</b>	Set a desired user name in 1 to 31 alphanumeric characters.
	Password <b>(pmw-200)</b>	Sets a password in 0 to 31 alphanumeric characters.
		<b>Note</b> Each password character is displayed as "*" .
	Set Execute / Cancel	Confirms the "Network" settings. Select "Execute" to confirm.

OTHERS		
Menu items	Subitems and setting values	Contents
	MAC Address	Display the MAC address.
	Net Config Reset Execute / Cancel	Reset the “Network” settings to the preset values. Select “Execute” to reset.
<b>Wi-Fi</b> (PMW-200 only) Setting for Wi-Fi connection	Scan Networks Execute / Cancel	Scan the available network connections when “Wi-Fi” is set to “Enable.”
	SSID (Network connection name display) Reset	Reset the network connection name to the default settings.
<b>Note</b> The CBK-WA01 Wi-Fi Adapter is required.	Network Type Infra / <b>Adhoc</b>	Select the connection mode. Infra: Infrastructure mode Adhoc: Ad hoc mode
	Ch <b>1</b> to 11	Set the wireless channel when “Network Type” is “Adhoc.”
	Authentication	Select the network authentication. Open: Open system authentication Shared: Shared key authentication WPA: WPA (Wi-Fi Protected Access) authentication WPA2: WPA2 (Wi-Fi Protected Access 2) authentication
	When “Network Type” is “Infra” <b>Open</b> / Shared / WPA / WPA2	
	When “Network Type” is “Adhoc” <b>Open</b> / Shared	
	Encryption	Select the type of data encryption. Disable: Do not apply data encryption. WEP: Apply WEP (Wired Equivalent Privacy) TKIP: Apply TKIP (Temporal Key Integrity Protocol) AES: Apply AES (Advanced Encryption Standard)
	When “Authentication” is “Open” or “Shared” <b>Disable</b> / WEP	
	When “Authentication” is “WPA” or “WPA2” <b>Disable</b> / TKIP / AES	
	WEP Key Index <b>1</b> / 2 / 3 / 4	Select the key index when “Encryption” is “WEP.”
	Input Select	Select the input format depending on the network key (or security key). ASCII5: Five characters ASCII format ASCII13: 13 characters ASCII format HEX10: 10 hexadecimal digits HEX26: 26 hexadecimal digits ASCII8-63: 8 to 63 characters ASCII 8-bit format HEX64: 64 hexadecimal digits (characters)
	When “Encryption” is “WEP” <b>ASCII5</b> / ASCII13 / HEX10 / HEX26	
	When “Encryption” is “TKIP” or “AES” ASCII8-63 / HEX64	
	Key (network key)	Set the network key (or security key).
Set Execute / Cancel	Confirm the “Wi-Fi” settings when “Wi-Fi” is set to “Enable.” Select “Execute” to confirm.	
Wi-Fi Status <b>■ ■</b> Connecting (display only)	Display “Connecting” while connection is being attempted. Display black squares to show the connection status by the number of squares during communication.	
Wireless Mode 802.11b / 802.11g / 802.11n	Display an IEEE802.11 standard.	
Wi-Fi Enable / <b>Disable</b>	Select whether to enable or disable Wi-Fi connection.	
<b>Version</b> Showing the version of this unit	Vx.xx	The current software version of the camcorder is displayed.

**OTHERS**

Menu items	Subitems and setting values	Contents
<b>Version (Lens)</b> (PMW-100 only) Showing the version of the lens	Vx.xx	The current lens version of the camcorder is displayed.
<b>Version Up</b> Updating this unit	Execute / Cancel	Select "Execute" to update the camcorder. Use when updating is required.
		<b>Note</b> This item cannot be selected when no SxS memory card has been loaded.
<b>Menu Scroll</b> Setting the menu scroll operation	Normal / Loop	Select the method for menu scrolling. Normal: The cursor moves and stops at the top or the bottom. Loop: The cursor continues moving up (jumping from the top to the bottom) or down (jumping from the bottom to the top).

1) If recording/playback cannot be made with an SxS memory card because it has been operated with a device other than this camcorder, or for some other reason, updating the managerial file on the card may improve the situation.

2) When you copy an SxS memory card including multiple clips and files to another card with the same capacity, all the clips and files may not be copied completely to the end, depending on the usage conditions or memory properties.

## Connecting External Monitors and Recording Devices

To display recording/playback pictures on an external monitor, select the output signal and use an appropriate cable for the monitor to be connected.

Output signal from the camcorder can be recorded when a recording device is connected. Regardless of whether the signal is HD or SD, the same status information and menus can be displayed on the external monitor as those on the LCD monitor/EVF screen.

According to the signal fed to the monitor, set “SDI/HDMI/Video Out Super” (page 88) in the VIDEO SET menu to “On.”

When outputting SD signals in HD Mode, select in advance the output mode (Squeeze, Letterbox, or Edge Crop) with “Down Converter” (page 89) in the VIDEO SET menu.

### Note

SD signals down-converted for output have the following restrictions:  
 Images of 50P/50i/25P are output as PAL signals, those of 59.94P/59.94i/29.97P are output as NTSC signals, and those of 23.98P are output as 2-3 pulled-down NTSC signals.

### SDI OUT connector (BNC type)

The connector is set at the factory to output an HD SDI signal.

When you set the camcorder to SD Mode, the connector outputs an SD SDI signal.

Set “SDI/HDMI/i.LINK I/O Select” (page 88) in the VIDEO SET menu to “SD SDI & SD HDMI i” to output down-converted SD SDI signals for monitoring, even in HD Mode. Use a commercially available 75-ohm coaxial cable for connection.

### To start recording on an external device in synchronization

With HD SDI signal output selected, synchronized recording is possible by feeding a REC trigger signal to an external recording device connected via the SDI OUT connector. To enable synchronized recording, set “SDI Rec Control” (page 89) in the VIDEO SET menu to “HD SDI Remote I/F.”

### Notes

- If you set “SDI/HDMI/i.LINK I/O Select” in the VIDEO SET menu to other than “HD SDI & HD HDMI” or “SD SDI & SD HDMI i” and use the HDMI OUT connector and i.LINK (HDV/DV) connector, no signal will be output from the SDI OUT connector.
- When a connected external device does not correspond to a REC trigger signal, the device cannot be operated.

### HDMI OUT connector (Type A connector)

Signal output from this connector is enabled by setting “SDI/HDMI/i.LINK I/O Select” (page 88) in the VIDEO SET menu.

In HD Mode, you can select HD HDMI, SD HDMI interlace, or SD HDMI Progressive output.

In SD Mode, only an SD HDMI interlace signal can be output.

Use a commercially available HDMI cable for connection.

### VIDEO OUT connector (BNC type)

By changing the setting of “SDI/HDMI/i.LINK I/O Select” (page 88) in the VIDEO SET menu, you can output HD-Y signals in HD Mode or down-converted SD analog composite signals for monitoring in SD Mode.

Use a commercially available BNC cable for connection.

### i.LINK (HDV/DV) connector (IEEE1394, 4-pin)

Input/output of an HDV or DVCAM stream can be enabled by changing “SDI/HDMI/i.LINK I/O Select” (page 88) in the VIDEO SET menu.

To set the input, select “i.LINK” in “Input Source Select” (page 88) in the VIDEO SET menu.

A monitor or VTR that supports i.LINK can be connected.

For details on i.LINK connection, see “Connecting via i.LINK (FAT only)” (page 106).

---

## A/V OUT connector (audio/video composite multiconnector)

---

By changing the setting of “SDI/HDMI/i.LINK I/O Select” (page 88) in the VIDEO SET menu, you can output 2-channel audio and down-converted SD analog composite signals for monitoring.

Use the supplied AV connection cable for connection.

# Operating Clips With a Computer

---

## To use the ExpressCard slot of a computer

---

If the computer is equipped with an ExpressCard/34 or ExpressCard/54 slot, you can directly insert the SxS memory card containing clips recorded with this camcorder and access to the files.

### Note

- The SxS Device Driver Software and the UDF Driver Software on the CD-ROM supplied with the camcorder must be installed on your computer.
- Operation is not guaranteed with all computers.

*For support information for the driver, visit the following URL:*

<http://www.sony.net/SxS-Support/>

With a Windows computer, check that a Removable Disk appears in My Computer. This indicates normal status.

With a Macintosh computer, an icon is displayed on the menu bar.

---

## To connect with a USB cable

---

When you connect the camcorder or the SBAC-US10 SxS Memory Card USB Reader/Writer (optional) using the supplied USB cable, the memory card in the slot is acknowledged as an extended drive by the computer.

When two memory cards are mounted in this camcorder, they are acknowledged as two independent extended drives by the computer.

### Note

The camcorder and the SBAC-US10 do not work on the bus power from the computer. Supply the operating power independently.



## To check the connection to the camcorder

### 1 Set the power switch to ON to turn on the camcorder.

A message prompting you to confirm that you wish to enable the USB connection is displayed on the LCD monitor/EVF screen.

#### Note

This message will not be displayed while another confirmation message or in-progress message (e.g., for formatting or restoration of an SxS memory card) is shown on the screen. It appears when formatting or restoration is completed. The message is also not displayed while the CLIP INFO screen is shown on the screen. It appears when an operation on the CLIP INFO screen is completed or you return to the thumbnail screen.

### 2 Select “Execute” by using the jog dial or the up/down/left/right buttons.

### 3 With Windows, check that the memory card is displayed as a removable disk in My Computer.

**With Macintosh, check that a “NO NAME” or “Untitled” folder was created on the desktop. (The Macintosh folder name can be changed.)**

#### Notes

- The following operations must be eliminated when the access lamp is lit in red.
  - Turning the power off or disconnecting the power cord
  - Removing the SxS memory card
  - Disconnecting the USB cable
- When removing an SxS memory card from a Macintosh, do not select “Card Power Off” from the SxS memory card icon displayed on the menu bar.
- Operation is not guaranteed with all computers.
- Use the supplied USB cable for connection.

---

## Using the supplied application software

---

To copy clips to the local disk of a computer, the dedicated application software in the supplied CD-ROM must be used.

Although the data regarding recorded materials are stored over multiple files and folders, you can easily handle the clips without considering such data and directory structure by using the dedicated application software.

#### Note

If you operate, e.g. copy the clips on the SxS memory card by using the Explorer (Windows) or Finder (Macintosh), the subsidiary data contained by the clips may not be maintained.

*For the operating requirements, installation and operations, refer to the User’s Guide contained in the CD-ROM.*

---

## Using a nonlinear editing system

---

For a nonlinear editing system, optional editing software that corresponds to the recording formats used with this camcorder is required.

Store the clips to be edited on the HDD of your computer in advance, using the dedicated application software (supplied).

## Connecting via i.LINK (FAT only)

When an HDV-compatible video format (SP 1440/59.94i, SP 1440/50i, or SP 1440/23.98P) or a DVCAM-compatible video format (format of SD Mode) is selected, setting “SDI/HDMI/i.LINK I/O Select” (page 88) in the VIDEO SET menu to “HDV” or “DVCAM” enables signal inputs/outputs via the i.LINK (HDV/DV) connector.

You can record the same images as those recorded on an SxS memory card in this camcorder on an external device connected to the i.LINK (HDV/DV) connector, or record playback pictures (HDV streams) of the external device on the memory card in the camcorder.

For playback, DVCAM streams of 16-bit 2-channel lock audio are acceptable.

Nonlinear editing conforming to the HDV format is also enabled.

### Notes

- DVCAM streams cannot be recorded with the camcorder.
- Use the i.LINK (HDV/DV) connector only for one-to-one i.LINK connection.
- When you change a setting which affects output signals from the i.LINK (HDV/DV) connector, such as “System” in the OTHERS menu or “SDI/HDMI/i.LINK I/O Select” and “Down Converter” in the VIDEO SET menu, disconnect the i.LINK cable then change the setting. Changing such a setting with the i.LINK cable connected may cause improper operation of the connected i.LINK device.

i.LINK and  are trademarks.

## Recording the Camcorder Picture on an External Device

While recording (or standing by to record), the picture being shot with this camcorder is output as an HDV or DVCAM stream via the i.LINK (HDV/DV) connector. It can be recorded on a connected HDV or DVCAM recorder in synchronization with the REC START/STOP operation on this camcorder.

### 1 Perform the preparatory settings of the camcorder.





- “SDI/HDMI/i.LINK I/O Select” (page 88) in the VIDEO SET menu
- “Trigger Mode” (page 96) in the OTHERS menu

### 2 Set the external device to recording standby status.

### 3 Start recording with the camcorder.

The external device starts recording in synchronization.

The status of the external device is displayed in the i.LINK status indication area (page 19) on the LCD monitor/EVF screen.

Indication	Status of the external device
STBY 	In HDV recording standby
●REC 	In HDV recording
STBY 	In DV recording standby
●REC 	In DV recording

### Notes

- Operation may be different depending on the type of external device.
- There is some time lag from when you start recording until the i.LINK status indication changes. Recording does not start on the connected i.LINK device before it enters synchronization even if “Trigger Mode” is set to “Both.”
- While you can record shot marks on the memory card during recording, they are not added to the pictures recorded on the external device.

## Nonlinear Editing

When the camcorder is displaying thumbnails or in playback mode, you can transfer an HDV stream to a nonlinear editing system connected via the i.LINK (HDV/DV) connector.

### Notes

- The i.LINK (HDV/DV) connector of this camcorder is a 4-pin connector. Check the number of pins of the i.LINK connector on your computer and use an appropriate i.LINK cable.
- In searching pictures of this camcorder on the computer, it may take some time until the display is reflected on the computer.
- If the playback clip is short or the playback starting point is near the end of the clip, the i.LINK signal may be interrupted between the clip and the next clip. When you try to capture such a signal using the nonlinear editing system, a malfunction may occur, depending on the nonlinear editing software in use.
- If you specify a search speed other than 4, 15, or 24 times normal with the nonlinear editing system, no i.LINK signal is fed out. In such a case, the picture on the LCD monitor may stay frozen.
- High-speed playback picture may not be displayed on the computer screen, depending on the nonlinear editing software in use.

### Setting on this camcorder

Set “SDI/HDMI/i.LINK I/O Select” (page 88) in the VIDEO SET menu to “HDV” or “DVCAM.”

## Recording External Input Signals

The HDV stream input from a device connected via the i.LINK connector can be recorded on an SxS memory card in this camcorder. The timecodes superimposed on the i.LINK input are recorded regardless of the settings of the camcorder.

### Note

DVCAM streams cannot be recorded.

### 1 Set the external signal to a format that can be recorded on the camcorder.

Signals of 1440 × 1080/59.94i can be recorded when “Format” (page 97) is set to SP 1440/59.94i or SP 1440/23.98P, and signals of 1440 × 1080/50i can be recorded when set to SP 1440/50i. Recording is not allowed with other combinations of “Video Format” and input signals.

### 2 Set “SDI/HDMI/i.LINK I/O Select” (page 88) in the VIDEO SET menu to “HDV.”

### 3 Set “Input Source Select” (page 88) in the VIDEO SET menu to “i.LINK.”

The input image is displayed on the LCD monitor/EVF screen and the monitor connected via the VIDEO OUT connector.

The audio signal is output from the built-in speaker, headphones connected to the headphone connector, and the speaker of the monitor connected to the AUDIO OUT connector.

### 4 Press the REC START/STOP button (page 15) or the REC START button (page 17).

Recording begins.

### Notes

- An error is generated in the following cases. In such a case, cancel Recording mode by pressing the REC START/STOP button.
  - The video format of input signal does not match that specified on the camcorder.
  - A copy-protected stream is being fed in.
- If the input to the camcorder becomes no signal during recording, the tally lamps and the i.LINK ●REC status indication on the LCD monitor/EVF screen flash, indicating that no signal is being recorded on the SxS memory card.

When an input signal is resumed, recording is restarted, incrementing the clip number on the memory card.

## External Synchronization

When multiple units of the camcorder are used in the same shooting location, recording can be made in synchronization with a specific reference signal, and the timecode can be matched among all the units.

### Aligning the phase of the video signal (Genlock)

Genlock operation is enabled by supplying a reference signal to the GENLOCK IN connector (*page 17*) of the camcorder.

Valid reference signals depend on the video format selected.

When the video format is UDF HD422 50/1080/23.98P or HD420 HQ/1080/23.98P, or FAT HQ 1920/23.98P, HQ 1440/23.98P, select either “23.98PsF” or “59.94i (2-3 Pull Down)” in “23.98P Output” (*page 89*) in the VIDEO SET menu.

#### For “NTSC/NTSC(J) Area”

##### UDF

Video format	Valid reference signal
HD422 50/1080/59.94i	1080/59.94i
HD422 50/1080/29.97P	NTSC
HD422 50/1080/23.98P (23.98P Output: 59.94i (2-3 Pull Down))	
HD422 50/1080/23.98P (23.98P Output: 23.98PsF)	1080/23.98PsF NTSC
HD422 50/720/59.94P	1080/59.94i
HD422 50/720/29.97P	720/59.94P
HD422 50/720/23.98P	NTSC
HD420 HQ/1080/59.94i	1080/59.94i
HD420 HQ/1080/29.97P	NTSC
HD420 HQ/1080/23.98P (23.98P Output: 59.94i (2-3 Pull Down))	
HD420 HQ/1080/23.98P (23.98P Output: 23.98PsF)	1080/23.98PsF NTSC
HD420 HQ/720/59.94P	1080/59.94i
HD420 HQ/720/23.98P	720/59.94P NTSC
DVCAM 59.94i SQ/EC	1080/59.94i
DVCAM 29.97P SQ/EC	NTSC

#### FAT

Video format	Valid reference signal
HQ 1920/59.94i	1080/59.94i
HQ 1920/29.97P	NTSC
HQ 1920/23.98P (23.98P Output: 59.94i(2-3 Pull Down))	
HQ 1920/23.98P (23.98P Output: 23.98PsF)	1080/23.98PsF NTSC
HQ 1440/59.94i	1080/59.94i
HQ 1440/29.97P	NTSC
HQ 1440/23.98P (23.98P Output: 59.94i(2-3 Pull Down))	
HQ 1440/23.98P (23.98P Output: 23.98PsF)	1080/23.98PsF NTSC
SP 1440/59.94i	1080/59.94i
SP 1440/23.98P	NTSC
HQ 1280/59.94P	1080/59.94i
HQ 1280/29.97P	720/59.94P
HQ 1280/23.98P	NTSC
DVCAM59.94i SQ/EC	1080/59.94i
DVCAM29.97P SQ/EC	NTSC

#### For “PAL Area”

##### UDF

Video format	Valid reference signal
HD422 50/1080/50i	1080/50i
HD422 50/1080/25P	PAL
HD422 50/720/50P	1080/50i
HD422 50/720/25P	720/50P PAL
HD420 HQ/1080/50i	1080/50i
HD420 HQ/1080/25P	PAL
HD420 HQ/720/50P	1080/50i 720/50P PAL
DVCAM50i SQ/EC	1080/50i
DVCAM25P SQ/EC	PAL

## FAT

Video format	Valid reference signal
HQ 1920/50i	1080/50i PAL
HQ 1920/25P	
HQ 1440/50i	
HQ 1440/25P	
SP 1440/50i	
HQ 1280/50P	1080/50i 720/50P PAL
HQ 1280/25P	
DVCAM50i SQ/EC	1080/50i PAL
DVCAM25P SQ/EC	

The phase adjustment for the reference signal can also be made with “Genlock” (page 96) in the OTHERS menu.

### Notes

- When the output format is SD mode and you use one of the video formats below, genlock is not possible. Set the video format to HD mode.  
UDF: HD422 50/720/59.94P, HD420 HQ/720/59.94P, HD422 50/720/50P, HD420 HQ/720/50P  
FAT: HQ 1280/59.94P, HQ 1280/50P
- If the reference signal is unstable, genlock is not possible.
- The subcarrier is not synchronized.

## Synchronizing the timecode of your camcorder with that of another unit

Set the unit that supplies the timecode to a mode in which the timecode output keeps advancing (Free Run or Clock mode).

### 1 Set “Timecode” in the TC/UB SET menu as follows:

Mode: Preset  
Run: Free Run

### 2 Press the DURATION/TC/U-BIT button (page 15) so that the timecode is displayed on the screen.

### 3 Confirm that the IN/OUT switch (page 17) is set to IN, then supply an HD or SD reference video signal to the GENLOCK IN connector and the reference timecode to the TC IN connector.

The built-in timecode generator of your camcorder locks to the reference timecode, and the message “EXT-LK” is displayed on the screen.

About 10 seconds after locking, even if the reference timecode from the external device is disconnected, the external lock will be kept.

### Notes

- Check that the reference timecode and the reference video signal are in a phase relation that complies the SMPTE timecode standards.
- When you finish the above procedure, the timecode is immediately synchronized with the external timecode, and the time data indication will show the value of the external timecode. However, wait for a few seconds until the timecode generator stabilizes before recording.
- If the frequency of the reference video signal and the frame frequency are not the same, a lock cannot be acquired, and the camcorder will not operate properly. In such a case, the timecode will not be correctly locked to the external timecode.
- When the connection is removed, the timecode advance may shift one frame per hour with respect to the reference timecode.

### To release the external timecode synchronization

Change the “Timecode” setting in the TC/UB SET menu set the camcorder to OFF.

External synchronization is also released when you start recording in a special recording mode (Slow & Quick Motion, Frame Rec, or Interval Rec).

## Synchronizing the timecode of another unit with that of your camcorder

### 1 Specify the timecode of your camcorder with “Timecode” and “TC Format” (page 44).

### 2 Confirm that the IN/OUT switch (page 17) is set to OUT, then connect the TC OUT connector and VIDEO OUT connector (page 17) with the timecode input and reference signal input of the other unit, respectively.

The timecode to be output from the TC OUT connector depends on the setting of “TC Out” in “Timecode” in the TC/UB SET menu. If “TC Out” is set to “Generator,” the timecode generated by the timecode generator of the camcorder is output during recording and playback. If “TC Out” is set to “Auto,” the timecode generated by the timecode generator is output during recording, and that superimposed with the video signal is output during playback.

## Important Notes on Operation

---

### Use and Storage

---

#### Do not subject the unit to severe shock

- The internal mechanism may be damaged or the body warped.
- If an accessory mounted on the accessory shoe is subjected to severe shock, the accessory shoe may be damaged. In such a case, stop using it and contact your dealer or a Sony service representative.

#### Do not cover the unit while operating

Putting a cloth, for example, over the unit can cause excessive internal heat build-up.

#### After use

Always set the power switch to OFF.

#### Before storing the unit for a long period

Remove the battery pack.

#### Grip the handle when carrying

Grip the handle to carry. If you carry it by other parts, such as the front microphone block or the LCD monitor block, the camcorder may drop, causing injury.

#### Do not leave the camcorder with the lenses facing the sun

Direct sunlight can enter through the lenses, be focused in the camcorder, and cause fire.

---

### Shipping

---

- Remove the memory cards before transporting the unit.
- If sending the unit by truck, ship, air or other transportation service, pack it in the shipping carton of the unit.

---

### Care of the unit

---

Remove dust and dirt from the surfaces of the lens using a blower.

If the body of the unit is dirty, clean it with a soft, dry cloth. In extreme cases, use a cloth steeped in a little neutral detergent, then wipe dry. Do not use organic solvents such as alcohol or thinner, as these may cause discoloration or other damage to the finish of the unit.

#### In the event of operating problems

If you should experience problems with the unit, contact your Sony dealer.

---

### Note about the battery terminal

---

The battery terminal of this unit (the connector for battery packs and AC adaptors) is a consumable part.

Power may not be supplied to the unit properly if the pins of the battery terminal are bent or deformed by shock or vibrations, or if they become corroded due to prolonged outdoor use. Periodic inspections are recommended to keep the unit working properly and to prolong its usable lifetime.

Contact a Sony service or sales representative for more information about inspections.

---

### Use and storage locations

---

Store in a level, ventilated place. Avoid using or storing the unit in the following places:

- In excessive heat or cold (operating temperature range: 0°C to 40°C or 32°F to 104°F)  
Remember that in summer in warm climates the temperature inside a car with the windows closed can easily exceed 50°C (122°F).
- In damp or dusty locations
- Locations where the unit may be exposed to rain
- Locations subject to violent vibration
- Near strong magnetic fields
- Close to radio or TV transmitters producing strong electromagnetic fields.
- In direct sunlight or close to heaters for extended periods

#### To prevent electromagnetic interference from portable communications devices

The use of portable telephones and other communications devices near this unit can result in malfunctions and interference with audio and video signals.

It is recommended that the portable communications devices near this unit be powered off.

## Note on laser beams

Laser beams may damage the CMOS image sensors. If you shoot a scene that includes a laser beam, be careful not to let the laser beam be directed into the lens of the camcorder.

---

## About the LCD panels

---

The LCD panels are manufactured with extremely high-precision technology that yields effective pixel rates of 99.99% or higher.

However, very rarely, one or more pixels may be permanently dark or permanently lit in white, red, blue, or green.

This phenomenon is not a malfunction. Such pixels have no effect on the recorded data, and the unit may be used with confidence even if they are present.

---

## Phenomena specific to CMOS image sensors

---

The following phenomena that may appear in images are specific to CMOS (Complementary Metal Oxide Semiconductor) image sensors. They do not indicate malfunctions.

### White flecks

Although the CMOS image sensors are produced with high-precision technologies, fine white flecks may be generated on the screen in rare cases, caused by cosmic rays, etc.

This is related to the principle of CMOS image sensors and is not a malfunction.

The white flecks especially tend to be seen in the following cases:

- when operating at a high environmental temperature
- when you have raised the master gain (sensitivity)
- when operating in Slow-Shutter mode

### Aliasing

When fine patterns, stripes, or lines are shot, they may appear jagged or flicker.

### Flicker

If recording is made under lighting produced by discharge tubes, such as fluorescent, sodium, or mercury-vapor lamps, the screen may flicker, colors may vary, or horizontal stripes may appear distorted.



In such cases, set the Flicker-Reduction function to Auto mode (*page 44*).

In some cases, such phenomena may not be improved with the Flicker-Reduction function.

It is recommend to set the electronic shutter speed to 1/100 sec. in 50-Hz areas and to 1/60 in 60-Hz areas.

### Focal plane

Owing to the characteristics of the pickup elements (CMOS sensors) for reading video signals, subjects that quickly move across the screen may appear slightly skewed.

### Flash band

The luminance at the top and bottom of the screen may change when shooting a flashlight beam or a light source that quickly flashes.

---

## Note on the EVF display

---

- Pictures on the LCD monitor and EVF screen may be distorted by the following operations:
  - Changing the video format
  - Rec Review
  - Starting playback from the Thumbnail screen
  - Reversing the LCD monitor
  - Switching the Expanded Focus display
- When you change the eye direction in the EVF, you may see primary colors red, green, and blue, but this is not a defect of the camcorder. These primary colors are not recorded on any recording media.

---

## Fragmentation

---

If pictures cannot be recorded/reproduced properly, try formatting the recording medium. While repeating picture recording/playback with a certain recording medium for an extended period, files in the medium may be fragmented, disabling proper recording/storage. In such a case, make a backup of clips in the medium then perform formatting of the medium using “Format Media” (*page 99*) in the OTHERS menu.

# Formats and Limitations of Outputs

## Video Formats and Output Signals

### Output formats for the SDI OUT connector

Serial digital signals from the SDI OUT connector are output depending on the settings of the setup menu and format of the clip being played.

The output format is converted when using the settings in the following chart.

#### Notes

- When the format is UDF HD Mode or FAT HD Mode and “SDI/HDMI/i.LINK I/O Select” in the VIDEO SET menu is set to “SD SDI & SD HDMI i,” a down-converted SD signal is output.
- When “SDI/HDMI/i.LINK I/O Select” in the VIDEO SET menu is set to other than “HD SDI & HD HDMI” or “SD SDI & SD HDMI i,” signals are not output from the SDI OUT connector.

### While recording (or standing by to record)/During clip playback

When recording: “Format” in “System” in the OTHERS menu When playing: Playback clip video format	Output format	
	Setting of “SDI/HDMI/i.LINK I/O Select” in the VIDEO SET menu	
	HD SDI & HD HDMI	SD SDI & SD HDMI i
HD422 50/1080/23.98P HD420 HQ/1080/23.98P HQ 1920/23.98P HQ 1440/23.98P (23.98P Output:59.94i (2-3 Pull Down))	1920×1080/59.94i <sup>1)</sup>	SD/59.94i <sup>1)</sup>
SP 1440/23.98P	1920×1080/59.94i <sup>1)</sup>	SD/59.94i <sup>1)</sup>
HD422 50/720/59.94P HD420 HQ/720/59.94P HQ 1280/59.94P	1280×720/59.94P	SD/59.94i <sup>2)</sup>
HD422 50/720/29.97P HQ 1280/29.97P	1280×720/59.94P <sup>3)</sup>	SD/29.97PsF
HD422 50/720/23.98P HD420 HQ/720/23.98P HQ 1280/23.98P	1280×720/59.94P <sup>4)</sup>	SD/59.94i <sup>1)</sup>
HD422 50/720/50P HD420 HQ/720/50P HQ 1280/50P	1280×720/50P	SD/50i <sup>5)</sup>
HD422 50/720/25P HQ 1280/25P	1280×720/50P <sup>6)</sup>	SD/25PsF

1) 59.94i provided through 2-3 pulldown of 23.98P.

2) 59.94i provided through conversion from 59.94P.

3) 59.94P provided by outputting each frame of 29.97P two times.

4) 59.94P provided by repeating each frame of 23.98P two or three times.

5) 50i provided through conversion from 50P.

6) 50P provided by outputting each frame of 25P two times.



**When a thumbnail screen is displayed**

“Format” in “System” in the OTHERS menu	Output format	
	Setting of “SDI/HDMI/i.LINK I/O Select” in the VIDEO SET menu	
	HD SDI & HD HDMI	SD SDI & SD HDMI i
HD422 50/1080/23.98P HD420 HQ/1080/23.98P HQ 1920/23.98P HQ 1440/23.98P (23.98P Output:59.94i (2-3 Pull Down))	1920×1080/59.94i <sup>1)</sup>	SD/59.94i
HD422 50/720/50P HD420 HQ/720/50P HQ 1280/50P	1280×720/50P	SD/50i <sup>2)</sup>

1)59.94i provided through 2-3 pulldown of 23.98P.

2)50i provided through conversion from 50P.

## Output formats from the HDMI OUT connector

Serial digital signals from the HDMI OUT connector are output depending on the settings of the setup menu and format of the clip being played.

The output format is converted when using the settings in the following chart.

### Note

When the format is UDF HD Mode or FAT HD Mode and “SDI/HDMI/i.LINK I/O Select” in the VIDEO SET menu is set to “SD SDI & SD HDMI i,” a down-converted SD signal is output.

### While recording (or standing by to record)/During clip playback

When recording: “Format” in “System” in the OTHERS menu When playing: Playback clip video format	Output format		
	Setting of “SDI/HDMI/i.LINK I/O Select” in the VIDEO SET menu		
	HD SDI & HD HDMI HD HDMI & HDV	SD SDI & SD HDMI i SD HDMI i & HDV SD HDMI i & DVCAM	SD HDMI P & HDV SD HDMI P
HD422 50/1080/23.98P HD420 HQ/1080/23.98P HQ 1920/23.98P HQ 1440/23.98P (23.98P Output: 59.94i (2-3 Pull Down))	1920×1080/59.94i <sup>1)</sup>	SD/59.94i <sup>1)</sup>	SD/59.94P
SP 1440/23.98P <sup>2)</sup>	1920×1080/59.94i <sup>1)</sup>	SD/59.94i <sup>1)</sup>	
HD422 50/720/59.94P HD420 HQ/720/59.94P HQ 1280/59.94P	1280×720/59.94P	SD/59.94i <sup>3)</sup>	
HD422 50/720/29.97P HQ 1280/29.97P	1280×720/59.94P <sup>4)</sup>	SD/29.97PsF	
HD422 50/720/23.98P HD420 HQ/720/23.98P HQ 1280/23.98P	1280×720/59.94P <sup>5)</sup>	SD/59.94i <sup>1)</sup>	
HD422 50/720/50P HD420 HQ/720/50P HQ 1280/50P	1280×720/50P	SD/50i <sup>6)</sup>	SD/50P
HD422 50/720/25P HQ 1280/25P	1280×720/50P <sup>7)</sup>	SD/25PsF	

1) 59.94i provided through 2-3 pulldown of 23.98P.

2) While recording (or standing by to record) only.

3) 59.94i provided through conversion from 59.94P.

4) 59.94P provided by outputting each frame of 29.97P two times.

5) 59.94P provided by repeating each frame of 23.98P two or three times.

6) 50i provided through conversion from 50P.

7) 50P provided by outputting each frame of 25P two times.

## When a thumbnail screen is displayed

“Format” in “System” in the OTHERS menu	Output format		
	Setting of “SDI/HDMI/i.LINK I/O Select” in the VIDEO SET menu		
	HD SDI & HD HDMI HD HDMI & HDV	SD SDI & SD HDMI i SD HDMI i & HDV SD HDMI i & DVCAM	SD HDMI P & HDV SD HDMI P
HD422 50/1080/23.98P HD420 HQ/1080/23.98P HQ 1920/23.98P HQ 1440/23.98P (23.98P Output: 59.94i (2-3 Pull Down))	1920×1080/59.94i <sup>1)</sup>	SD/59.94i	SD/59.94P

<sup>1)</sup>59.94i provided through 2-3 pulldown of 23.98P.

## Output formats from the VIDEO OUT connector

Signals output from the VIDEO OUT connector are either the HD-Y signals output from the SDI OUT connector/HDMI OUT connector (when outputting HD from the SDI OUT connector or HDMI OUT connector), or analog composite signals (when outputting SD from the SDI OUT connector or HDMI OUT connector).

Signals of clips recorded in a different system from the setting of “Country” in “System” in the OTHERS menu are converted to the following frame rates for simplified playback before output.

### When you play clips recorded with the PAL system while the “Country” is set to “NTSC Area/NTSC(J) Area.”

Some frames may be repeated due to frame rate conversion.

Playback clip video format	VIDEO OUT Output format	
	HD-Y	Analog composite
HD422 50/1080/50i HD420 HQ/1080/50i HQ 1920/50i HQ 1440/50i SP 1440/50i	1920×1080/60i	SD/59.94i
HD422 50/1080/25P HD420 HQ/1080/25P HQ 1920/25P HQ 1440/25P	1920×1080/30PsF	SD/29.97PsF
HD422 50/720/50P HD420 HQ/720/50P HQ 1280/50P	1280×720/60P	SD/59.94i
HD422 50/720/25P HQ 1280/25P		SD/29.97PsF
DVCAM50i SQ/EC	Cannot be played	Cannot be played
DVCAM25P SQ/EC		

**When you play clips recorded with the NTSC system while the “Country” is set to “PAL Area.”**

Some frames may be deleted due to frame rate conversion.

Playback clip video format	VIDEO OUT Output format	
	HD-Y	Analog composite
HD422 50/1080/59.94i HD420 HQ/1080/59.94i HQ 1920/59.94i HQ 1440/59.94i SP 1440/59.94i	1920×1080/49.95i	SD/50i
HD422 50/1080/29.97P HD420 HQ/1080/29.97P HQ 1920/29.97P HQ 1440/29.97P	1920×1080/24.97PsF	SD/25PsF
HD422 50/1080/23.98P HD420 HQ/1080/23.98P HQ 1920/23.98P HQ 1440/23.98P SP 1440/23.98P		
HD422 50/720/59.94P HD420 HQ/720/59.94P HQ 1280/59.94P	1280×720/49.95P	SD/50i
HD422 50/720/29.97P HQ 1280/29.97P		SD/25PsF
HD422 50/720/23.98P HD420 HQ/720/23.98P HQ 1280/23.98P		
DVCAM59.94i SQ/EC	Cannot be played	Cannot be played
DVCAM29.97P SQ/EC		

## Output formats from the i.LINK I/O connector

Serial digital signals from the i.LINK I/O connector are output in the following formats depending on the settings of the setup menu and format of the clip being played.

### Note

When “SDI/HDMI/i.LINK I/O Select” in the VIDEO SET menu is set to “HD SDI & HD HDMI,” “SD SDI & SD HDMI i,” or “SD HDMI P,” signals are not output from the i.LINK I/O connector.

### While recording (or standing by to record)/When playing a clip

When recording: “Format” in “System” in the OTHERS menu When playing: Playback clip video format	Output format	
	Setting of “SDI/HDMI/i.LINK I/O Select” in the VIDEO SET menu	
	HD HDMI & HDV SD HDMI i & HDV SD HDMI P & HDV	SD HDMI i & DVCAM
HQ 1920/59.94i HQ 1440/59.94i	No signal	SD/59.94i
HQ 1920/29.97P HQ 1440/29.97P		SD/29.97PsF
HQ 1920/23.98P HQ 1440/23.98P		No signal
SP 1440/59.94i		SD/59.94i
SP 1440/23.98P	1440×1080/59.94i <sup>1)</sup>	SD/59.94i <sup>1)</sup>
HQ 1280/59.94P	No signal	SD/59.94i <sup>2)</sup>
HQ 1280/29.97P		SD/29.97PsF
HQ 1280/23.98P		No signal
DVCAM59.94i SQ/EC		SD/59.94i
DVCAM29.97P SQ/EC		SD/29.97PsF
HQ 1920/50i HQ 1440/50i		No signal
HQ 1920/25P HQ 1440/25P	SD/25PsF	
SP 1440/50i	SD/50i	
HQ 1280/50P	SD/50i <sup>3)</sup>	
HQ 1280/25P	No signal	SD/25PsF
DVCAM50i SQ/EC		SD/50i
DVCAM25P SQ/EC		SD/25PsF

1) 59.94i provided through 2-3 pulldown of 23.98P.

2) 59.94i provided through conversion from 59.94P.

3) 50i provided through conversion from 50P.

## Limitations of Inputs/Outputs

The outputs from the camcorder are limited by the menu settings as follows:

x: no signal

Menu setting			Output					Input
System		SDI/HDMI/ i.LINK I/O Select	SDI OUT	HDMI OUT	i.LINK	VIDEO OUT	A/V Out	i.LINK
UDF/ FAT	HD/SD							
UDF	HD	HD SDI & HD HDMI	HD	HD	x	HD-Y	x	x
		SD SDI & SD HDMI i	SD	SD	x	Composite	Composite	x
		HD HDMI & HDV	x	x	x	x	x	x
		SD HDMI i & HDV	x	x	x	x	x	x
		SD HDMI P & HDV	x	x	x	x	x	x
		SD HDMI i & DVCAM	x	x	x	x	x	x
		SD HDMI P	x	SD-P	x	x	x	x
		Off	x	x	x	Composite	Composite	x
FAT	HD/HQ	HD SDI & HD HDMI	HD	HD	x	HD-Y	x	x
		SD SDI & SD HDMI i	SD	SD	x	Composite	Composite	x
		HD HDMI & HDV	x	x	x	x	x	x
		SD HDMI i & HDV	x	x	x	x	x	x
		SD HDMI P & HDV	x	x	x	x	x	x
		SD HDMI i & DVCAM	x	SD	DVCAM	Composite	Composite	DVCAM (display only)
		SD HDMI P	x	SD-P	x	x	x	x
		Off	x	x	x	Composite	Composite	x
	HD/SP	HD SDI & HD HDMI	HD	HD	x	HD-Y	x	x
		SD SDI & SD HDMI i	SD	SD	x	Composite	Composite	x
		HD HDMI & HDV	x	HD	HDV	HD-Y	x	HDV
		SD HDMI i & HDV	x	SD	HDV	Composite	Composite	HDV
		SD HDMI P & HDV	x	SD-P	HDV	x	x	HDV
		SD HDMI i & DVCAM	x	SD	DVCAM	Composite	Composite	x
		SD HDMI P	x	x	x	x	x	x
Off		x	x	x	Composite	Composite	x	

Menu setting			Output					Input
System		SDI/HDMI/ i.LINK I/O Select	SDI OUT	HDMI OUT	i.LINK	VIDEO OUT	A/V Out	i.LINK
UDF/ FAT	HD/SD							
UDF	SD	HD SDI & HD HDMI	×	×	×	×	×	×
		SD SDI & SD HDMI i	SD	SD	×	Composite	Composite	×
		HD HDMI & HDV	×	×	×	×	×	×
		SD HDMI i & HDV	×	×	×	×	×	×
		SD HDMI P & HDV	×	×	×	×	×	×
		SD HDMI i & DVCAM	×	×	×	×	×	×
		SD HDMI P	×	×	×	×	×	×
		Off	×	×	×	Composite	Composite	×
FAT		HD SDI & HD HDMI	×	×	×	×	×	×
		SD SDI & SD HDMI i	SD	SD	×	Composite	Composite	×
		HD HDMI & HDV	×	×	×	×	×	×
		SD HDMI i & HDV	×	×	×	×	×	×
		SD HDMI P & HDV	×	×	×	×	×	×
		SD HDMI i & DVCAM	×	SD	DVCAM	Composite	Composite	DVCAM (display only)
		SD HDMI P	×	×	×	×	×	×
		Off	×	×	×	Composite	Composite	×

# Backup Battery Replacement

This camcorder uses a backup battery to retain various setting data.

A lithium battery (CR2032) for backup is mounted in the camcorder at the factory. The backup battery retains the date, time, and timecode in Free Run mode even when no operating power is being supplied.

## Service life of the backup battery

When the backup battery's voltage falls, the backup battery low-voltage warning appears on the LCD monitor/EVF screen.

If this warning appears, replace the battery as soon as possible.

### WARNING

- Battery may explode if mistreated. Do not recharge, disassemble, or dispose of in fire.
- Batteries shall not be exposed to excessive heat such as sunshine, fire or the like.

### CAUTION

Danger of explosion if battery is incorrectly replaced. Replace only with the same or equivalent type recommended by the manufacturer.

When you dispose of the battery, you must obey the law in the relative area or country.

## Replacing the backup battery

### Notes

- Be sure to set the power switch to OFF when replacing the backup battery.
- Be careful not to drop the removed screw into the camcorder.

- 1 Remove the screw of the backup battery holder (page 18), then remove the cover. Insert a nonmetallic item, such as a plastic toothpick, to the side of the battery and lever the battery out of its compartment.**

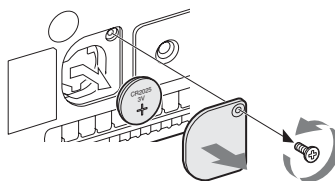

- 2 Insert a new backup battery (CR2032) with the + symbol on the battery facing outside.**



- 3 Attach the cover in the original position.**

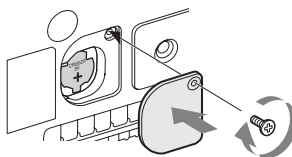



# Troubleshooting

## Power

Symptoms	Cause	Remedy
The camcorder does not power on when you set the power switch to ON.	No battery pack is mounted and no power is supplied to the DC IN connector.	Mount a battery pack ( <i>page 21</i> ) or connect to AC power using the BC-U1 or BC-U2 ( <i>page 22</i> ).
	The battery pack is completely exhausted.	Replace the battery pack with a fully charged one ( <i>page 21</i> ).
The power supply cuts while operating.	The battery pack becomes exhausted.	Replace the battery pack with a fully charged one ( <i>page 21</i> ).
The battery pack becomes exhausted very quickly.	The ambient temperature is very low.	This owes to the battery characteristics and is not a defect.
	The battery pack is inadequately charged.	Recharge the battery pack ( <i>page 21</i> ). If the battery pack is soon exhausted even after you charged it fully, it may come to the end of its life. Replace it with a new one.

## Recording/Playback

Symptoms	Cause	Remedy
Recording does not start when you press the REC START/STOP button.	The power switch is set to OFF.	Set the power switch to ON.
	The SxS memory card is write-protected.	Release the write-protection, or replace the card with a non-protected SxS memory card.
	The SxS memory card is full.	Replace the card with one having sufficient space.
	The SxS memory card needs restoration.	Restore the memory card ( <i>page 26</i> ).
Playback does not start when you press the PLAY button.	The power switch is set to OFF.	Set the power switch to ON.
The supplied IR Remote Commander does not work.	Remote control operation is disabled.	Enable remote control operation ( <i>page 24</i> ).
	The battery of the IR Remote Commander is exhausted.	Replace the battery with a new one.
Audio recording is not possible.	The AUDIO LEVEL (CH-1/CH-2) controls are set to the minimum level.	Adjust the audio recording levels with the AUDIO LEVEL (CH-1/CH-2) controls ( <i>page 45</i> ).
The recorded sound is distorted.	The audio level is too high.	Adjust the audio recording levels with the AUDIO LEVEL (CH-1/CH-2) controls ( <i>page 45</i> ), and record again.
The recorded sound has a high noise level.	The audio level is too low.	Adjust the audio recording levels with the AUDIO LEVEL (CH-1/CH-2) controls ( <i>page 45</i> ), and record again.

## External Devices

Symptoms	Cause	Remedy
The equipment connected to the camcorder via an i.LINK connection does not react as expected, for example, no picture appears on its screen.	It sometimes takes time for the connected equipment to recognize the operation.	Wait for about 15 seconds. If the connected equipment still does not react, do the following: <ul style="list-style-type: none"><li>• Check the i.LINK cable, for example, by re-plugging it.</li><li>• Turn the power off, and connect the cable again.</li><li>• Change the i.LINK cable.</li></ul>

# Error/Warning Indications

The camcorder informs you of situations where warning, caution, or an operation check is required, through messages on the LCD monitor/EVF screen, the tally lamps, and a buzzer. The buzzer is output to the built-in speaker or to the headphones connected via the headphone connector. The buzzer volume can be set with “Alarm Level” in “Audio Output” (page 87) in the AUDIO SET menu.

## Error Indications

The camcorder stops operation after the following indications.

Error indication on LCD/EVF	Buzzer	Tally lamps	Cause and measures
E + Error code	Continuous	Rapidly flashing	The camcorder may be defective. Recording stops even if ●REC is displayed on the LCD monitor/EVF screen. Turn off the power and check the connected equipment, cables, and media. If they are not defective, turn on the power again. If the error persists, consult Sony service personnel. (If power cannot be turned off by setting the power switch to OFF, remove both the battery pack or the DC IN source.)

## Warning Indications

When one of the following indications is generated, follow the message to clear the problem.

Warning indication on LCD/EVF	Buzzer	Tally lamps	Cause and measures
Media Near Full	Intermittent	Flashing	Free space on the SxS memory card has become insufficient. Replace it with another at the earliest opportunity.
Media Full	Continuous	Rapidly flashing	No space is left on the SxS memory card. Recording, clip copying and clip division cannot be performed. Replace it with another.
Battery Near End	Intermittent	Flashing	The battery power will be exhausted soon. Charge the battery pack at the earliest opportunity.
Battery End	Continuous	Rapidly flashing	The battery pack is exhausted. Recording cannot be performed. Stop operation and change the battery pack.
Temperature High	Intermittent	Flashing	The internal temperature has risen above a safe operation limit. Suspend operation, turn off the power, and wait until the temperature falls.
Voltage Low	Intermittent	Flashing	The DC IN voltage has become low (stage 1). Check the power supply.
Insufficient Voltage	Continuous	Rapidly flashing	The DC IN voltage is too low (stage 2). Recording cannot be performed. Connect other power source.
HDD A <sup>1)</sup> Battery Near End	Intermittent	Flashing	The battery power of the connected HDD will be exhausted soon. Change the battery at the earliest opportunity.
HDD A <sup>1)</sup> Battery End	Continuous	Rapidly flashing	The battery of the connected HDD is exhausted. Recording cannot be performed. Stop operation to change the battery.

Warning indication on LCD/EVF	Buzzer	Tally lamps	Cause and measures
Battery Error Please Change Battery			An error was detected with the battery pack. Replace the battery pack with a normal one.
Backup Battery End Please Change			The remaining power of the backup battery is insufficient. Replace the battery with a new one.
Unknown Media(A) <sup>2</sup> Please Change			A partitioned memory card or one that contains recorded clips exceeding the number permitted with this camcorder is loaded. This card cannot be used with this camcorder. Remove it and load a compatible card.
Media Error Media(A) <sup>2</sup> Needs to be Restored			An error occurred with the memory card. The card requires restoration. Remove the card, load it again, and restore it.
Media Error Cannot Record to Media(A) <sup>2</sup>			Recording cannot be done, as the memory card is defective. As playback may be possible, it is recommended to replace it with another card after copying the clips, as required.
Media Error Cannot Use Media(A) <sup>2</sup>			Neither recording nor playback can be done, as the memory card is defective. It cannot be operated with this camcorder. Replace it with another card.
Will Switch Slots Soon			This is an advanced notice that the camcorder will switch from the current memory card to the other memory card for continuous recording.
No Clip			There are no clips in the memory card. Check the selected card.
Cannot Use Media(A) <sup>2</sup> Unsupported File System			A card of a different file system or an unformatted card was inserted. It cannot be used with this camcorder. Replace it with another card or format it with this camcorder.
Cannot Use Media(A) <sup>2</sup> In UDF Mode			A memory card incompatible with UDF mode is inserted. Replace the card from the respective slot, format it with the camcorder, or switch to UDF FAT mode.
Same File Already Exists Change Media(A) <sup>2</sup>			A clip with the same name exists in the memory card to which you want to copy. Replace the card from the respective slot with a different card.
Video Format Mismatch			The external signal input via the i.LINK connection cannot be recorded, as the "Format" setting is different from the signal format of the external input signal. Change "Format" in "System" in the OTHERS menu to match it to that of the external signal.
Copy Protected Input Cannot Record			The external signal input via the i.LINK connection cannot be recorded, as the stream is copy-protected. Check the input signal.
Media Error Playback Halted			An error occurred in reading data from the memory card, and playback cannot be continued. If this frequently occurs, change the memory card after copying the clips, as required.
Media(A) <sup>2</sup> Error			Recording cannot be done, as an error occurred with the memory card. If this frequently occurs, change the memory card.
Media Reached Rewriting Limit Change Media (A) <sup>2</sup>			The memory card comes to the end of its service life. Make a backup copy and replace the card with another one as soon as possible. Recording/playback may not be performed properly if you continue to use the card.  <i>For details, refer to the operating instructions of the memory card.</i>

Warning indication on LCD/EVF	Buzzer	Tally lamps	Cause and measures
Reached Clip Number Limit Copy Completed to xx/xx			The maximum number of clips for 1 memory card is reached, so copying cannot continue. (xx/xx indicates the completed copy operations.) Replace the card.
Not Enough Capacity Copy Completed to xx/xx			There is not enough capacity for copying. (xx/xx indicates the completed copy operations.) Replace the card.
Reached Duplication Limit Copy Completed to xx/xx			There are already 10 or more clips with the same name as the clip that you want to copy, so copying cannot continue. (xx/xx indicates the completed copy operations.) Replace the card.
Copy Error! (CANCEL:Abort) No Media!			There is no memory card inserted in the slot. Insert a card.
Copy Error! (CANCEL:Abort) Media Write Protected			The memory card is write-protected. Remove the card from the slot and remove the write-protection.
Copy Error! (CANCEL:Abort) Cannot Use Media(A) <sup>2)</sup>			A memory card that cannot be used with the camcorder is inserted. Replace the card in the respective slot.
Copy General Files NG: Cannot Copy			Copying of a general file failed. Retry copying.
File System Mismatch			A memory card with an different file system is inserted. Replace the card, format it with the camcorder, or switch to UDF FAT mode.

1)B for a HDD connected to slot B

2)(B) for the card in slot B

# Licenses

## MPEG-2 Video Patent Portfolio License

ANY USE OF THIS PRODUCT OTHER THAN CONSUMER PERSONAL USE IN ANY MANNER THAT COMPLIES WITH THE MPEG-2 STANDARD FOR ENCODING VIDEO INFORMATION FOR PACKAGED MEDIA IS EXPRESSLY PROHIBITED WITHOUT A LICENSE UNDER APPLICABLE PATENTS IN THE MPEG-2 PATENT PORTFOLIO, WHICH LICENSE IS AVAILABLE FROM MPEG LA, L.L.C., 250 STEELE STREET, SUITE 300, DENVER, COLORADO 80206.

“PACKAGED MEDIA” means any storage media storing MPEG-2 video information such as DVD movie which are sold/distributed to general consumers. Disc replicators or sellers of the PACKAGED MEDIA need to obtain licenses for their own business from MPEG LA. Please contact MPEG LA for any further information. MPEG LA, L.L.C., 250 STEELE STREET, SUITE 300, DENVER, COLORADO 80206 <http://www.mpegla.com>

## Bitmap Fonts

This product uses RICOH Bitmap Fonts produced and sold by Ricoh Company, Ltd.

## On accessing software to which the GPL applies

This product uses software to which the GPL version 2 applies. This informs you that you have a right to have access to, modify, and redistribute source code for these software programs under the conditions of the GPL version 2.

The source code is provided on the internet. Use the following URL and follow the download instructions.

<http://www.sony.net/Products/Linux/common/search.html>

We would prefer that you do not contact us about the contents of the source code.

# About OpenSSL

Because it uses the OpenSSL Toolkit, this product uses software developed by the OpenSSL Project (<http://www.openssl.org/>).

## OpenSSL License

-----

/\*

=====  
=====

=====

\* Copyright (c) 1998-2008 The OpenSSL  
\* Project. All rights reserved.

\*  
\* Redistribution and use in source and  
\* binary forms, with or without  
\* modification, are permitted provided  
\* that the following conditions are met:

\* 1. Redistributions of source code must  
\* retain the above copyright notice,  
\* this list of conditions and the  
\* following disclaimer.

\* 2. Redistributions in binary form must  
\* reproduce the above copyright  
\* notice, this list of conditions and the  
\* following disclaimer in the  
\* documentation and/or other  
\* materials provided with the  
\* distribution.

\* 3. All advertising materials mentioning  
\* features or use of this software must  
\* display the following  
\* acknowledgment:  
\* "This product includes software  
\* developed by the OpenSSL Project  
\* for use in the OpenSSL Toolkit.  
\* (<http://www.openssl.org/>)"

\* 4. The names "OpenSSL Toolkit" and  
\* "OpenSSL Project" must not be used  
\* to endorse or promote products  
\* derived from this software without  
\* prior written permission. For written  
\* permission, please contact [openssl-core@openssl.org](mailto:openssl-core@openssl.org).

\*  
\* 5. Products derived from this software  
\* may not be called "OpenSSL" nor  
\* may "OpenSSL" appear in their  
\* names without prior written  
\* permission of the OpenSSL Project.

\* 6. Redistributions of any form  
\* whatsoever must retain the following  
\* acknowledgment:  
\* "This product includes software  
\* developed by the OpenSSL Project  
\* for use in the OpenSSL Toolkit  
\* (<http://www.openssl.org/>)"

\* THIS SOFTWARE IS PROVIDED BY  
\* THE OpenSSL PROJECT ``AS IS"  
\* AND ANY EXPRESSED OR IMPLIED  
\* WARRANTIES, INCLUDING, BUT NOT  
\* LIMITED TO, THE IMPLIED  
\* WARRANTIES OF MERCHANTABILITY  
\* AND FITNESS FOR A PARTICULAR  
\* PURPOSE ARE DISCLAIMED. IN NO  
\* EVENT SHALL THE OpenSSL  
\* PROJECT OR ITS CONTRIBUTORS BE  
\* LIABLE FOR ANY DIRECT, INDIRECT,  
\* INCIDENTAL, SPECIAL, EXEMPLARY,  
\* OR CONSEQUENTIAL DAMAGES  
\* (INCLUDING, BUT NOT LIMITED TO,  
\* PROCUREMENT OF SUBSTITUTE  
\* GOODS OR SERVICES;  
\* LOSS OF USE, DATA, OR PROFITS;  
\* OR BUSINESS INTERRUPTION)  
\* HOWEVER CAUSED AND ON ANY  
\* THEORY OF LIABILITY, WHETHER IN  
\* CONTRACT, STRICT LIABILITY, OR  
\* TORT (INCLUDING NEGLIGENCE OR  
\* OTHERWISE)  
\* ARISING IN ANY WAY OUT OF THE  
\* USE OF THIS SOFTWARE, EVEN IF  
\* ADVISED OF THE POSSIBILITY OF  
\* SUCH DAMAGE.

```

=====
=====
*
* This product includes cryptographic
* software written by Eric Young
* (eay@cryptsoft.com). This product
* includes software written by Tim
* Hudson (tjh@cryptsoft.com).
*
* /

```

Original SSLeay License

```

-----
* Copyright (C) 1995-1998 Eric Young
* (eay@cryptsoft.com)
* All rights reserved.
*
* This package is an SSL
* implementation written by Eric Young
* (eay@cryptsoft.com).
* The implementation was written so as
* to conform with Netscapes SSL.
*
* This library is free for commercial and
* non-commercial use as long as the
* following conditions are aheard to.
* The following conditions apply to all
* code found in this distribution, be it the
* RC4, RSA, lhash, DES, etc., code; not
* just the SSL code. The SSL
* documentation included with this
* distribution is covered by the same
* copyright terms except that the holder
* is Tim Hudson (tjh@cryptsoft.com).
*
* Copyright remains Eric Young's, and
* as such any Copyright notices in the
* code are not to be removed.
* If this package is used in a product,
* Eric Young should be given attribution
* as the author of the parts of the library
* used.
* This can be in the form of a textual
* message at program startup or in
* documentation (online or textual)
* provided with the package.
*
* Redistribution and use in source and
* binary forms, with or without
* modification, are permitted provided
* that the following conditions are met:

```

```

* 1. Redistributions of source code must
* retain the copyright notice, this list of
* conditions and the following
* disclaimer.
* 2. Redistributions in binary form must
* reproduce the above copyright
* notice, this list of conditions and the
* following disclaimer in the
* documentation and/or other
* materials provided with the
* distribution.
* 3. All advertising materials mentioning
* features or use of this software must
* display the following
* acknowledgement:
* "This product includes
* cryptographic software written by
* Eric Young (eay@cryptsoft.com)"
* The word 'cryptographic' can be left
* out if the routines from the library
* being used are not cryptographic
* related :-).
* 4. If you include any Windows specific
* code (or a derivative thereof) from
* the apps directory (application
* code) you must include an
* acknowledgement:
* "This product includes software
* written by Tim Hudson
* (tjh@cryptsoft.com)"
*
* THIS SOFTWARE IS PROVIDED BY
* ERIC YOUNG ``AS IS" AND ANY
* EXPRESS OR IMPLIED WARRANTIES,
* INCLUDING, BUT NOT LIMITED TO,
* THE IMPLIED WARRANTIES OF
* MERCHANTABILITY AND FITNESS
* FOR A PARTICULAR PURPOSE ARE
* DISCLAIMED. IN NO EVENT SHALL
* THE AUTHOR OR CONTRIBUTORS BE
* LIABLE FOR ANY DIRECT, INDIRECT,
* INCIDENTAL, SPECIAL, EXEMPLARY,
* OR CONSEQUENTIAL DAMAGES
* (INCLUDING, BUT NOT LIMITED TO,
* PROCUREMENT OF SUBSTITUTE
* GOODS OR SERVICES; LOSS OF USE,
* DATA, OR PROFITS; OR BUSINESS
* INTERRUPTION)
* HOWEVER CAUSED AND ON ANY
* THEORY OF LIABILITY, WHETHER IN
* CONTRACT, STRICT LIABILITY, OR
* TORT (INCLUDING NEGLIGENCE OR

```



\* OTHERWISE) ARISING IN ANY WAY  
\* OUT OF THE USE OF THIS SOFTWARE,  
\* EVEN IF ADVISED OF THE  
\* POSSIBILITY OF SUCH DAMAGE.

\*

\* The licence and distribution terms for  
\* any publically available version or  
\* derivative of this code cannot be  
\* changed. i.e. this code cannot simply  
\* be copied and put under another  
\* distribution licence [including the GNU  
\* Public Licence.]

\* /



# Specifications

## General

### Mass

#### PMW-200

Approx. 2.3 kg (5 lb 1.1 oz) (Camcorder only)

Approx. 2.7 kg (5 lb 15 oz) (With lens hood (1), eyecup (1), battery pack BP-U30 (1), SxS memory card (1))

#### PMW-100

Approx. 1.5 kg (3 lb 4.9 oz) (Camcorder only)

Approx. 1.8 kg (3 lb 15 oz) (With lens hood (1), eyecup (1), battery pack BP-U30 (1), SxS memory card (1))

### Dimensions

#### PMW-200

Approx. W172 mm × H164 mm × D419 mm  
(6 <sup>7</sup>/<sub>8</sub> × 6 <sup>1</sup>/<sub>2</sub> × 16 <sup>1</sup>/<sub>2</sub> inches)  
(Outermost dimensions. Depth is the length from the tip of a front microphone to an EVF eyecup.)

Approx. W172 mm × H164 mm × D317 mm  
(6 <sup>7</sup>/<sub>8</sub> × 6 <sup>1</sup>/<sub>2</sub> × 12 <sup>1</sup>/<sub>2</sub> inches)  
(Not including extruding parts. Depth is the length from the tip of a front microphone to the back of the unit.)

#### PMW-100

Approx. W167 mm × H164 mm × D335 mm  
(6 <sup>5</sup>/<sub>8</sub> × 6 <sup>1</sup>/<sub>2</sub> × 13 <sup>1</sup>/<sub>4</sub> inches)  
(Outermost dimensions. Depth is the length from the tip of a front microphone to an EVF eyecup.)

Approx. W167 mm × H164 mm × D278 mm  
(6 <sup>5</sup>/<sub>8</sub> × 6 <sup>1</sup>/<sub>2</sub> × 11 <sup>1</sup>/<sub>8</sub> inches) (Not including extruding parts. Depth is the

length from the tip of a front microphone to the back of the unit.)

### Power requirements

DC 12 V (11.0 V ~ 17.0 V)

### Power consumption

Approx. 12 W  
while recording with LCD Off, EVF On and I/O Select Off

Approx. 14 W  
while recording with LCD On, EVF On and I/O Select HD SDI & HD HDMI

### Inrush current

- (1) Maximum possible inrush current at initial switch-on (Voltage changes caused by manual switching): 50 A peak, 9.5 A r.m.s. (240V AC)
- (2) Inrush current after a mains interruption of five seconds (Voltage changes caused at zero-crossing): 3 A peak, 0.7 A r.m.s. (240V AC)

### Operating temperature

0°C ~ +40°C

### Storage temperature

-20°C ~ +60°C

### Continuous operation time

- (While recording with LCD Off, EVF On and I/O Select Off)
- With battery pack BP-U90: approx. 6 hours
- With battery pack BP-U60: approx. 4 hours
- With battery pack BP-U30: approx. 2 hours

### Recording format (video)

- UDF**
- HD422 mode: MPEG-2 422P@HL, 50Mbps / CBR
- HD420 mode: MPEG-2 MP@HL, 35Mbps / VBR
- DVCAM mode: DVCAM

**FAT**  
HQ 1920 mode: MPEG-2 MP@HL,  
35Mbps / VBR  
HQ 1440 mode: MPEG-2 MP@HL,  
35Mbps / VBR  
HQ 1280 mode: MPEG-2 MP@HL,  
35Mbps / VBR  
SP 1440 mode: MPEG-2 MP@H-14,  
25 Mbps / CBR  
DVCAM mode: DVCAM

---

### Recording format (audio)

**UDF**  
HD422 mode: LPCM (24-bit, 48 kHz, 4  
channels)  
Other modes: LPCM (16-bit, 48 kHz, 4  
channels)

**FAT**  
HD Mode: LPCM (16-bit, 48 kHz, 4  
channels)  
SD Mode: LPCM (16-bit, 48 kHz, 2  
channels)

---

### Recording frame rate

**UDF**  
HD422 mode: MPEG-2 422P@HL,  
50Mbps / CBR  
1920 × 1080/59.94i, 50i, 29.97p, 25p,  
23.98p  
1280 × 720/59.94p, 50p, 29.97p, 25p,  
23.98p  
HD420 mode: MPEG-2 MP@HL,  
35Mbps / VBR  
1440 × 1080/59.94i, 50i, 29.97p, 25p,  
23.98p  
1280 × 720/59.94p, 50p, 23.98p  
DVCAM mode  
720 × 486/59.94i, 29.97PsF  
720 × 576/50i, 25PsF

**FAT**  
HQ 1920 mode: MPEG-2 MP@HL,  
35Mbps / VBR  
1920 × 1080/59.94i, 50i, 29.97p, 25p,  
23.98p  
HQ 1440 mode: MPEG-2 MP@HL,  
35Mbps / VBR

1440 × 1080/59.94i, 50i, 29.97p, 25p,  
23.98p  
HQ 1280 mode: MPEG-2 MP@HL,  
35Mbps / VBR  
1280 × 720/59.94p, 50p, 29.97p, 25p,  
23.98p  
SP 1440 mode: MPEG-2 MP@H-14,  
25Mbps / CBR  
1440 × 1080/59.94i, 50i, 23.98p (2-3  
pull down)  
DVCAM mode  
720 × 480/59.94i, 29.97PsF  
720 × 576/50i, 25PsF

---

### Recording/playback time

**UDF**  
HD422 mode  
When using SBP-64 / SBS-64G1A  
(64GB): Approx. 120 minutes  
When using SBP-32 / SBS-32G1A  
(32GB): Approx. 60 minutes  
When using SBP-16 (16GB): Approx  
30 minutes

HD420 mode  
When using SBP-64 / SBS-64G1A  
(64GB): Approx. 180 minutes  
When using SBP-32 / SBS-32G1A  
(32GB): Approx. 90 minutes  
When using SBP-16 (16GB): Approx.  
45 minutes

DVCAM mode  
When using SBP-64 / SBS-64G1A  
(64GB): Approx. 220 minutes  
When using SBP-32 / SBS-32G1A  
(32GB): Approx. 110 minutes  
When using SBP-16 (16GB): Approx.  
55 minutes

**FAT**  
HQ 1920/HQ 1440/HQ 1280 mode  
When using SBP-64 / SBS-64G1A  
(64GB): Approx. 200 minutes  
When using SBP-32 / SBS-32G1A  
(32GB): Approx. 100 minutes  
When using SBP-16 (16GB): Approx.  
50 minutes  
SP 1440 mode

When using SBP-64 / SBS-64G1A (64GB): Approx. 280 minutes  
When using SBP-32 / SBS-32G1A (32GB): Approx. 140 minutes  
When using SBP-16 (16GB): Approx. 70 minutes  
DVCAM mode  
When using SBP-64 / SBS-64G1A (64GB): Approx. 260 minutes  
When using SBP-32 / SBS-32G1A (32GB): Approx. 130 minutes  
When using SBP-16 (16GB): Approx. 65 minutes

#### Note

These approximate playback times depend on operating conditions, available memory, etc.

## Lens

### PMW-200

#### Lens mount

Fixed type

#### Zoom ratio

14x, power/manual switchable

#### Maximum relative aperture

1:1.9

#### Focal length

5.8 mm ~ 81.2 mm  
(equivalent to 31.4 mm ~ 439 mm on a 35 mm lens)

#### Focus area

Auto/manual switchable  
800 mm to ∞ (macro OFF)  
50 mm to ∞ (macro ON, wide end)  
735 mm to ∞ (macro ON, tele end)

#### Iris

Auto/manual switchable  
F1.9 to F16 and C (close)

#### Picture stabilizing function

ON/OFF possible, shift-lens system

#### Filter thread

M 77 mm, pitch 0.75 mm

#### Macro

ON/OFF possible

### PMW-100

#### Lens mount

Fixed type

#### Zoom ratio

10x, power/manual switchable

#### Focal length

5.4 mm ~ 54 mm  
(equivalent to 40 mm ~ 400 mm on a 35 mm lens)

#### Focus area

Auto/manual switchable  
10 mm to ∞ (wide end)  
800 mm to ∞ (tele end)

#### Iris

Auto/manual switchable  
F1.8 to F2.9

#### Picture stabilizing function

ON/OFF possible, shift-lens system

#### Filter thread

M 37mm, pitch 0.75 mm

## Camera Block

#### Pickup device

PMW-200: 1/2-inch triple chip "Exmor" CMOS image sensor  
PMW-100: 1/2.9-inch single-chip "Exmor" CMOS image sensor

#### Effective picture elements

1920 (H) × 1080 (V)

#### Built-in filters (PMW-200 only)

ND filters  
CLEAR: Clear  
1: 1/8ND  
2: 1/64ND

---

**Minimum subject illumination**

PMW-200: 0.12 lx (typical) (1920 × 1080/59.94i, F1.9, +18 dB, 64-frame accumulation)

PMW-100: 0.40 lx (typical) (1920 × 1080/59.94i, F1.8, +18 dB, 64-frame accumulation)

---

**Shutter speed**

1/32 ~ 1/2000 sec.

---

**Slow Shutter (SLS/EX SLS)**

2, 3, 4, 5, 6, 7, 8, 16, 32, 64 frames

---

**Slow & Quick Motion**

720p: 1 ~ 60 frames, 1 ~ 50 frames (for PAL Area, UDF)

1080p: 1 ~ 30 frames, 1 ~ 25 frames (for PAL Area, UDF)

---

**White balance**

Preset mode (3200K), Memory A mode, Memory B mode/ATW mode

---

**Gain**

-3, 0, 3, 6, 9, 12, 18 dB, AGC

---

## Inputs/Outputs

---

**Audio input**

XLR type 3-pin (2), female, LINE/MIC/ MIC+48V switchable

LINE: +4 dBu

MIC: -70 dBu to -30 dBu

(Reference input level 0 dBu=0.775 Vrms)

---

**Video output**

BNC type (1), switchable with GENLOCK IN connector, HD-Y/ composite signal

1.0 Vp-p, 75 Ω

---

**AV multi-output**

AV multi-connector (1), audio output, composite signal

Audio: -10 dBu (Under 47 kΩ load, reference level)

Analog composite signal: NTSC or PAL

---

---

**SDI output**

BNC type (1), switchable with HD-SDI/ SD-SDI

SMPTE292M/259M

---

**i.LINK**

IEEE 1394, 4-pin connector (1), HDV (HDV 1080i) / DV input/output, S400

---

**Timecode input**

BNC type (1), switchable with TC OUT connector

0.5 V to 18 Vp-p, 10 kΩ

---

**Timecode output**

BNC type (1), switchable with TC IN connector

1.0 Vp-p, 10 kΩ

---

**GENLOCK input**

BNC type (1), switchable with VIDEO OUT connector

1.0 Vp-p, 75 Ω

---

**USB**

mini-B (1)

---

**Headphone output**

Stereo minijack (1)

-18 dBu (Reference level output under 16Ω load)

---

**Speaker output**

Monaural

Output: 250 mW

---

**DC input**

DC jack

---

**HDMI output**

Type A (1)

---

**LENS REMOTE (lens remote controller) connector (PMW-200 only)**

8-pin round (1)

---

**External device connector (PMW-200 only)**

4-pin (Type A) (1)

---

## Displays

### Viewfinder

PMW-200: 0.45-inch color LCD: 852 (H) × 480 (V), 16:9

PMW-100: 0.24-inch color LCD: 392 (H) × 224 (V), 16:9

### LCD monitor

3.5-inch color LCD monitor: 852 (H) × 3 (RGB) × 480 (V), 16:9

## Internal Microphone

### Internal microphone

Omnidirectional stereo electret condenser microphone

## Media Slot Block

### Type

ExpressCard/34 (2)

## Package Configuration

Lens hood (1)

This is pre-installed to the PMW-200.

Lens cap (PMW-100 only) (1)

This is pre-installed to the camcorder.

Infrared Remote Commander (1)

EVF eyecup (1)

USB cable (1)

AV connecting cable (1)

Shoulder strap (1)

Wi-Fi adaptor bracket (PMW-200 only) (1)

Microphone cable holder (PMW-200 only) (1)

Screws for mounting microphone cable holder (PMW-200 only) (1)

BP-U30 battery pack (1)

Battery Charger/AC Adaptor: BC-U1 (1)

Lithium battery (CR2032 for backup) (1)

This is pre-installed to the camcorder.

Lithium battery (CR2025 for the IR Remote Commander) (1)

This is pre-installed to the IR Remote Commander.

### CD-ROM

Utility Software (1)

Operating instructions in PDF (1)

Operating Instructions (1)

## About the supplied CD-ROMs

### Utility Software

The supplied CD-ROM contains application and device driver software required to access to SxS memory cards from a computer and to manage material shot with the camcorder. Information about how to install the software is provided in PDF format.

### Notes

- You must install the SxS device driver and the UDF driver software on your computer if your computer is equipped with an ExpressCard slot and you want to use it to access SxS memory cards, or if you want to connect the camcorder to your computer.
- If you have lost or damaged the CD-ROM, you can purchase a new one to replace it. Contact your Sony service representative.

### Operating instructions in PDF

The operating instructions for this camcorder are included on the CD-ROM.

### Memo

To read PDF files, Adobe Reader 6.0 or higher must be installed.

If Adobe Reader is not installed or your version of Adobe Reader cannot view the files properly, you can download the newest version of the software from the following URL:  
<http://www.adobe.com/>

Adobe and Adobe Reader are trademarks of Adobe Systems Incorporated in the United States and/or other countries.

## Optional Accessories

Battery pack

BP-U30, BP-U60, BP-U90

Battery charger/AC adaptor

BC-U1, BC-U2

SxS memory card

SxS PRO Series

SxS-I Series

SxS memory card USB reader/writer

SBAC-US10

Media Adaptor

QDA-EX1 (for XQD memory cards)

MEAD-MS01 (for “Memory Stick PRO-HG Duo” HX series)

MEAD-SD01 (for SDHC cards)

Electret condenser microphone

ECM-673, ECM-MS2

Wireless microphone

UWP-V1\*, UWP-V2\*

Wide-conversion lens

VCL-HG0737K (PMW-100)

VCL-EX0877 (PMW-200)

Hard disk unit

PHU-220R\*

Memory recording unit

HVR-MRC1K\*

\* To attach accessories to the rear accessory shoe, use the optional cold shoe kit (part no.: X-2546-633-1).

Design and specifications are subject to change without notice.

**Notes**

- Always make a test recording, and verify that it was recorded successfully.  
SONY WILL NOT BE LIABLE FOR DAMAGES OF ANY KIND INCLUDING, BUT NOT LIMITED TO, COMPENSATION OR REIMBURSEMENT ON ACCOUNT OF FAILURE OF THIS UNIT OR ITS RECORDING MEDIA, EXTERNAL STORAGE SYSTEMS OR ANY OTHER MEDIA OR STORAGE SYSTEMS TO RECORD CONTENT OF ANY TYPE.
- Always verify that the unit is operating properly before use. SONY WILL NOT BE LIABLE FOR DAMAGES OF ANY KIND INCLUDING, BUT NOT LIMITED TO, COMPENSATION OR REIMBURSEMENT ON ACCOUNT OF THE LOSS OF PRESENT OR PROSPECTIVE PROFITS DUE TO FAILURE OF THIS UNIT, EITHER DURING THE WARRANTY PERIOD OR AFTER EXPIRATION OF THE WARRANTY, OR FOR ANY OTHER REASON WHATSOEVER.

# Index

## Numerics

23.98P Output 89

## A

A/V OUT connector 104  
AC Adaptor 21  
AC Power 22  
ACCESS lamps 25  
AGC mode 40  
All Reset 94  
All-Clip thumbnail screen 64  
Aperture 57  
Area Detection 58  
assignable buttons 48, 95  
ATW 39  
ATW Speed 85  
Audio Input 86  
AUDIO LEVEL knobs 46  
audio monitoring 46  
Audio Output 87  
audio recording levels 45  
AUDIO SELECT switches 46  
AUDIO SET Menu 86  
AUDIO Status 75  
Auto Naming 37  
Auto Shutter 41  
Auto White Balance 39  
Auto-Tracing White balance 39

## B

backlight 23  
backup battery 120  
Battery Alarm 96  
Battery Charger 21  
Battery INFO 96  
Battery Pack 21  
Battery/Media Status Screen 76  
Black 58  
Black Gamma 58  
built-in speaker 66  
built-in stereo microphones 45  
Button/Remote Status Screen 75

## C

Camera Data 94  
CAMERA SET Menu 80  
CAMERA Status Screen 74  
Charge Count 76  
Clip 37, 65, 98, 104  
Clip Cont. Rec 49, 83  
Clip Name Disp 100  
Clip name 37  
Clip Operation menu 66  
Clock 22  
Clock Set 94  
CMOS Image Sensors 111  
Color Bars 81  
Color Correction 54  
Color Detection 58  
Copy 58  
Copy All 99  
Country 97  
Cueing up 66

## D

DC IN connector 22  
DC IN Power 22  
delete shot marks 72  
Deleting Clips 59  
Depth-of-Field indication 20  
Detail 55  
Direct Menu 20, 96  
DISP CLIP INFO 68  
DISPLAY button 19  
Display On/Off 90  
Down Converter 89  
DURATION/TC/U-BIT button 44

## E

Electronic Shutter 40  
Electronic Viewfinder 23  
Entering a character string 79  
Error Indications 123  
EVF 23, 89  
EX Slow Shutter 81  
EX SLS 41  
EXPAND (COARSE) 71  
EXPAND (FINE) 71  
EXPAND CLIP Screen 67, 70  
EXPAND FOCUS button 42



Exposure 41, 85  
ExpressCard slot 104  
External Hard Disk 27  
External Input Signals 107  
External Monitors 103  
External Synchronization 108  
eyepiece focusing knob 23

## F

Flicker Reduce 44, 82  
Flickers 44  
Focus 42  
Format 30, 97  
Format Media 99  
Frame Recording 48, 83  
FULL AUTO button 36  
Full Auto mode 36  
Full MF mode 42

## G

Gain 40  
Gain Setup 80  
Gamma 57  
Genlock 96  
GENLOCK IN connector 108

## H

handle ZOOM button 42  
HD Detail 55  
HD/SD 97  
HDMI OUT connector 103  
headphone connector 46  
Histogram indication 20  
Hours Meter 96

## I

i.LINK 19, 106  
i.LINK connector 103  
Image Alignment 51  
Image Inversion 85  
Input Source Select 88  
Interval Recording 48, 83  
IR Remote 18, 24, 96

## J

Jog dial 78

## K

Knee 57  
KP Flag 47

## L

Language 94  
LCD 23, 89  
LCD/VF SET Menu 89  
Lens hood 13  
LENS REMOTE connector 42  
Limitations of Inputs/Outputs 118  
Low Key SAT 58

## M

Macro mode 43  
MACRO switch 43  
Marker 40, 90  
Matrix 53  
MEAD-MS01 30  
MEAD-SD01 30  
Media Adaptor 29  
Media Full 26  
Media Near Full 26  
Memory A mode 39  
Memory B mode 39  
Memory Stick 30  
MENU button 78  
Menu Scroll 102  
MF Assist 81  
microphone holder 45  
Monitoring audio 46  
Multi Matrix 53

## N

Network 100  
NG Flag 47  
NightShot 43, 85  
Nonlinear Editing 107

## O

OK Flag 47  
OK Mark 47  
OK-Clip thumbnail screen 64  
OTHERS Menu 94  
Output Signal 112

## P

P.Cache Rec 83  
PAUSE 71, 72  
Peaking 42, 89  
PEAKING button 42  
PHU-220R 27  
Picture Cache Recording 50  
Picture Profiles 52  
Plan.Metadata 60, 99  
Planning metadata 60  
PLAY/PAUSE button 65  
Power Zoom 42  
PP Data 58  
Preset mode 39  
Preventing switching errors 37  
Profile Name 53

## R

REC HOLD lever 37  
Rec Review 47, 83  
REC REVIEW button 37  
REC START/STOP button 37  
Recording audio signals 45  
recording start mark 49, 67  
Reference Tone 46  
Reset 58

## S

S&Q Motion 51, 83  
SBAC-US10 104  
SD Detail 56  
SDHC Cards 30  
SDI OUT connector 103  
SDI Rec Control 89, 103  
SDI/HDMI/i.LINK I/O Select 88  
SEL/SET buttons 78  
SEL/SET dial 78  
Setting Data 59  
Setup Menus 77, 80  
Shockless White 84  
SHOT MARK 46, 67  
SHOT MARK Screen 67, 71  
shot marks 46, 66, 72  
Shutter 80  
Skin Tone Detail 56  
SLOT SELECT button 64  
Slow & Quick Motion 50

SLS/EX SLS 81  
Status Screens 74  
Steady Shot 43  
SxS Device Driver Software 104  
SxS Memory Cards 25  
System 97

## T

Tally 96  
TC Format 93  
TC IN connector 109  
TC Out 109  
TC OUT connector 109  
TC/UB SET Menu 92  
THUMBNAIL button 64  
Thumbnail Screens 63, 66  
time and date 22  
Time Data 44  
Time Zone 22, 94  
Timecode 44, 92, 108  
TLCS 20, 36, 84  
Trigger Mode 96, 106

## U

UDF/FAT 97  
USB cable 104  
USB Flash Drives 30  
Users Bit 44, 92  
UTC 22

## V

Version 101  
Version Up 102  
Video Formats 38  
VIDEO OUT connector 103  
VIDEO SET Menu 88  
Video Status Screen 75  
Viewfinder 23  
VOLUME buttons 46, 66

## W

Warning Indications 123  
White 54  
WHITE BAL button 39  
WHITE BAL switch 39  
White Balance 39  
White Switch <B> 84

Wide Conversion 43, 85  
wide-conversion lens 43  
Wi-Fi 101  
Wi-Fi Adapter 32

## **X**

XQD Memory Cards 29

## **Z**

Zebra 40, 90  
zebra pattern 40  
Zoom 41  
Zoom Speed 42, 82  
Zoom Transition 82



